



**HEWLETT
PACKARD**

OPERATION AND SERVICE MANUAL

**85650A
QUASI-PEAK ADAPTER**

SERIAL NUMBERS

This manual applies directly to instruments with serial number prefixed 2043A.

For additional important information about serial numbers, see **INSTRUMENTS COVERED BY MANUAL** in Section I.

Copyright © 1981, HEWLETT-PACKARD COMPANY
1400 FOUNTAIN GROVE PARKWAY, SANTA ROSA, CALIFORNIA, 95404, U.S.A.

MANUAL PART NO. 85650-90001
Microfiche No. 85650-90011

Printed: May 1981

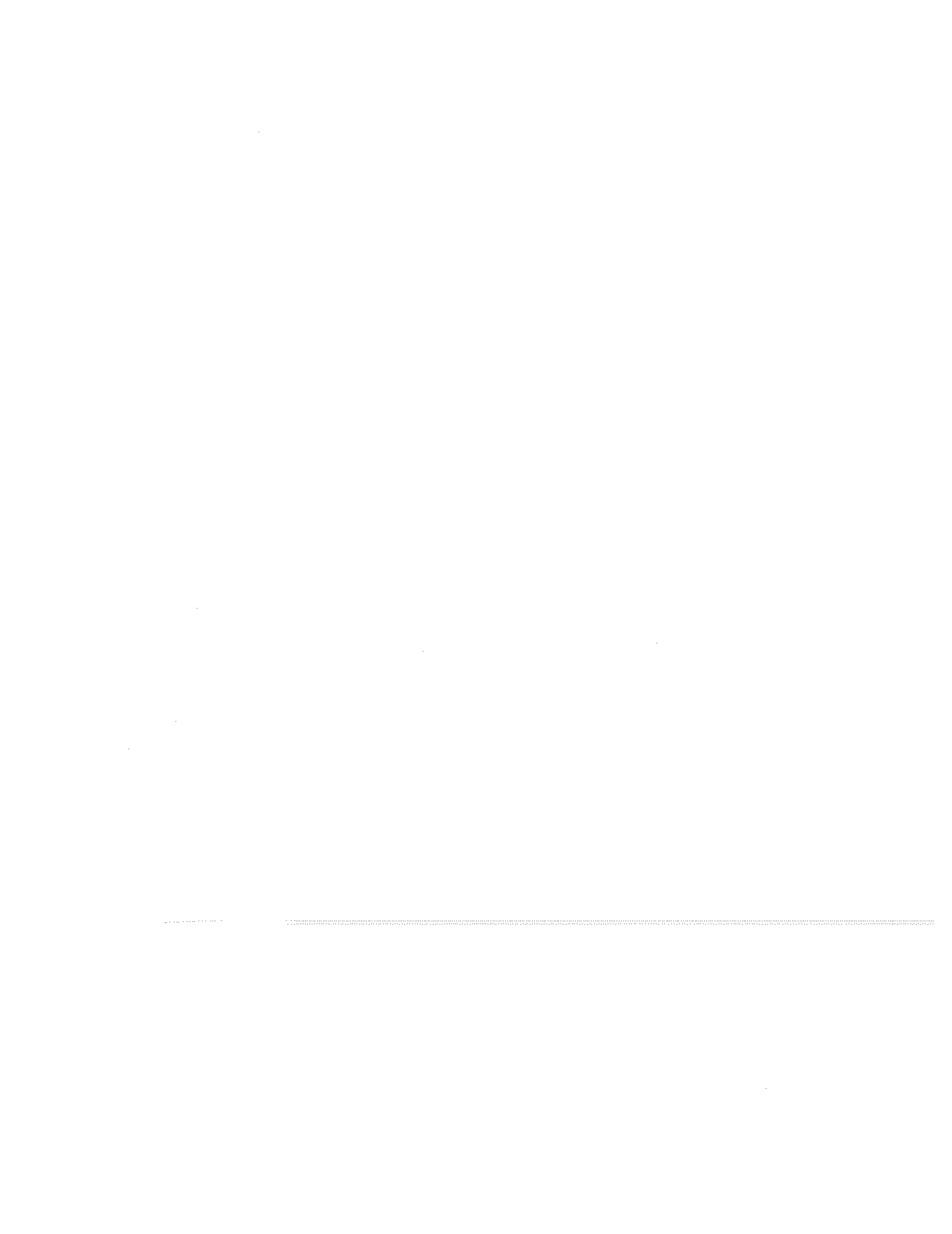

SAFETY CONSIDERATIONS

Safety Symbols

The following safety symbols are used throughout this manual and in the instrument. Familiarize yourself with each of the symbols and its meaning before operating this instrument.



Instruction manual symbol: the apparatus will be marked with this symbol when it is necessary for the user to refer to the instruction manual in order to protect the apparatus against damage.



Indicates dangerous voltages.

CAUTION

The CAUTION sign denotes a hazard. It calls attention to an operation procedure, practice, or the like, which, if not correctly performed or adhered to, could result in damage to or destruc-

tion of part or all of the equipment. Do not proceed beyond a CAUTION sign until the indicated conditions are fully understood and met.

WARNING

The WARNING sign denotes a hazard. It calls attention to a procedure, practice, or the like, which, if not correctly performed or adhered to, could result in injury or loss of life. Do not proceed beyond a WARNING sign until the indicated conditions are fully understood and met.

Operation

WARNING

BEFORE THIS INSTRUMENT IS SWITCHED ON, its rear panel power module protective earth terminal must be connected through the protective conductor of the ac power cable to a socket outlet provided with protective earth contact. Failure to ground the instrument can result in personal injury.

WARNING

The HP 85650A Quasi-Peak Adapter should not be operated without protective covers. Adjustments and service

procedures which require operation of the HP 85650A with the covers removed should be performed only by trained service personnel.

CAUTION

BEFORE THIS INSTRUMENT IS SWITCHED ON, make sure that its rear panel power module switch is set to the voltage of the ac power source. Failure to set the ac power input to the correct voltage could cause damage to the instrument when the ac power cable is plugged in.

Service and Adjustments

WARNING

There are voltages at many points in the instrument which can, if contacted, cause personal injury. Be extremely careful. Service and adjustments should be performed only by trained service personnel.

WARNING

Any interruption of the protective (grounding) conductor, inside or outside the instrument, or disconnection of the protective earth terminal may cause personal injury.

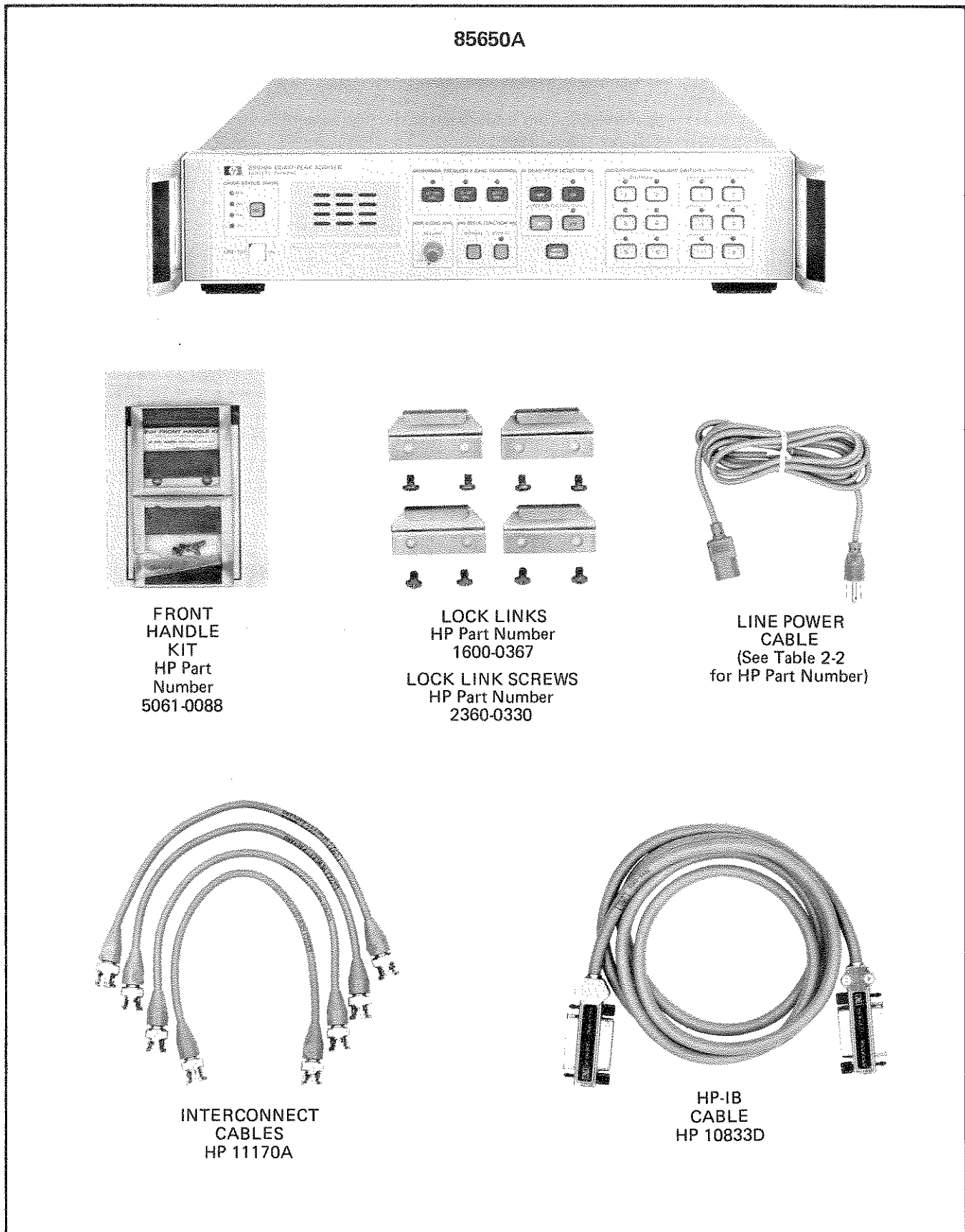

Figure 1-1. HP Model 85650A Quasi-Peak Adapter with Accessories Supplied

SECTION I GENERAL INFORMATION

1-1. INTRODUCTION

1-2. This Operation and Service manual contains information required to install, operate, test, adjust, and service the Hewlett-Packard Model 85650A Quasi-Peak Adapter. Figure 1-1 shows the instrument and accessories supplied. This section covers instrument identification, description, options, accessories, specifications, and other basic information.

1-3. DESCRIPTION

1-4. The HP 85650A Quasi-Peak Adapter is a Hewlett-Packard Interface Bus (HP-IB) programmable accessory for use with the HP 8566A or HP 8568A Option 650 Spectrum Analyzers.

1-5. When interconnected, the quasi-peak adapter and spectrum analyzer provide the capability for detection and measurement analysis of electromagnetic interference (EMI).

1-6. The HP 85650A provides the resolution bandwidths and time constants required by Publication 16 of Comite International Special des Perturbations Radioelectriques (CISPR). The instrument also contains circuitry which, when used in conjunction with a power supply to control remote RF coaxial switches, allows certain accessories to be switched in and out of the measurement system. (Refer to paragraph entitled 'Auxiliary Switches for Control of Accessories' in Section II.) A bypass mode is provided to allow use of the spectrum analyzer, unaffected by the quasi-peak adapter, when the two instruments are connected as a system.

1-7. MANUAL ORGANIZATION

1-8. This manual is divided into eight sections as follows:

SECTION I, GENERAL INFORMATION, contains the instrument description and specifications, explains accessories and options, and lists recommended test equipment.

SECTION II, INSTALLATION, contains information concerning initial inspection, preparation for use, operating environment, and packaging and shipping.

SECTION III, OPERATION, contains detailed instructions for operation of the instrument.

SECTION IV, PERFORMANCE TESTS, contains the tests to verify that the electrical operation of the instrument is in accordance with published specifications.

SECTION V, ADJUSTMENTS, contains the procedures to properly adjust the instrument after repair.

SECTION VI, REPLACEABLE PARTS, contains the information necessary to order parts and assemblies for the instrument.

SECTION VII, MANUAL BACKDATING CHANGES, contains backdating information to make this manual compatible with earlier equipment configurations.

SECTION VIII, SERVICE, contains schematic diagrams, block diagrams, component locations illustrations, circuit descriptions, and troubleshooting information to aid in repair of the instrument.

1-9. SPECIFICATIONS

1-10. Instrument specifications are listed in Table 1-1. These specifications are the performance standards or limits against which the instrument is tested. Table 1-2 lists supplemental characteristics. Supplemental characteristics are not specifications but are typical characteristics included as additional information for the user.

1-11. INSTRUMENTS COVERED BY MANUAL

1-12. Serial Numbers

1-13. A serial number plate is attached to the rear panel of the instrument. The serial number is in

two parts. The first four digits and letter are the serial number prefix; the last five digits are the suffix. (See Figure 1-2.) The prefix is the same for all identical instruments; it changes only when a change is made to the instrument. The suffix, however, is assigned sequentially and is different for each instrument. This manual applies to instruments with the serial number prefixes listed under SERIAL NUMBERS on the title page.

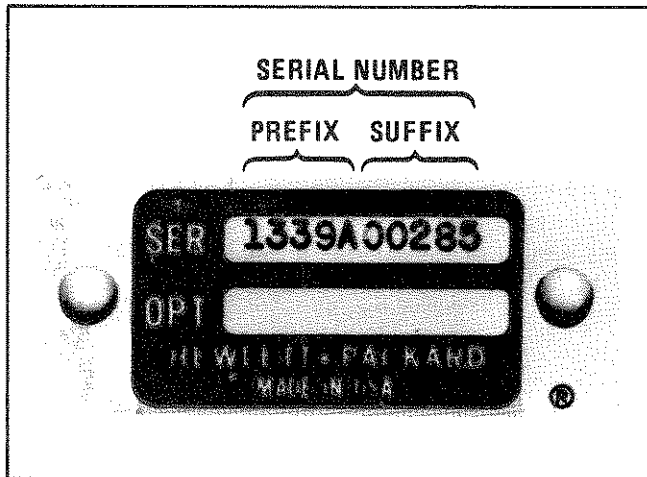

Figure 1-2. Typical Serial Number Plate

1-14. Manual Changes Supplement

1-15. An instrument manufactured after the printing of this manual might have a serial number prefix that is not listed on the title page. This unlisted serial number prefix indicates the instrument is different from those described in the manual. The manual for this newer instrument is accompanied by a yellow Manual Changes supplement, which provides information that explains how to adapt the manual to the newer instrument.

1-16. In addition to change information, the supplement might contain information for correcting errors in the manual. To keep this manual as cur-

rent and accurate as possible, Hewlett-Packard recommends that you periodically request the latest Manual Changes supplement. The supplement contains a manual identification block that includes the model number, print date of the manual, and manual part number. Complimentary copies of the supplement are available from Hewlett-Packard. Addresses of Hewlett-Packard offices are located at the end of this manual.

1-17. Manual Backdating Changes

1-18. Since the current manual has not been revised, there is no backdating information provided in Section VII.

1-19. EQUIPMENT REQUIRED BUT NOT SUPPLIED

1-20. To enable detection and measurement, the HP 85650A Quasi-Peak Adapter must be interconnected to an HP 8566A or HP 8568A Option 650 Spectrum Analyzer. A modification kit, HP Part Number 85650-60050, is available for field installation of Option 650. Service Notes 8566A-15 and 8568A-39, which are included in the kit, provide detailed installation instructions. HP 8568A Spectrum Analyzers with IF-Display Sections whose serial prefixes are 1745A and below require additional modifications described in Service Note 8568A-40.

1-21. SERVICE ACCESSORIES

1-22. A service accessories package for the instrument is available for convenience in troubleshooting the instrument. Contents of this package are indicated in Table 1-4. The complete package can be obtained from Hewlett-Packard by ordering HP Part Number 85650-60051, Check Digit 7.

Table 1-1. HP Model 85650A Specifications (1 of 2)

FREQUENCY SPECIFICATIONS

BANDPASS FILTER SELECTIVITY

Bandpass filter response characteristics conform to the limits of overall selectivity specified by Publication 16 of Comite International Special des Perturbations Radioelectriques (CISPR). The curve representing the overall selectivity of the HP 85650A shall lie within the limits shown in Figures 1, 2, and 3.

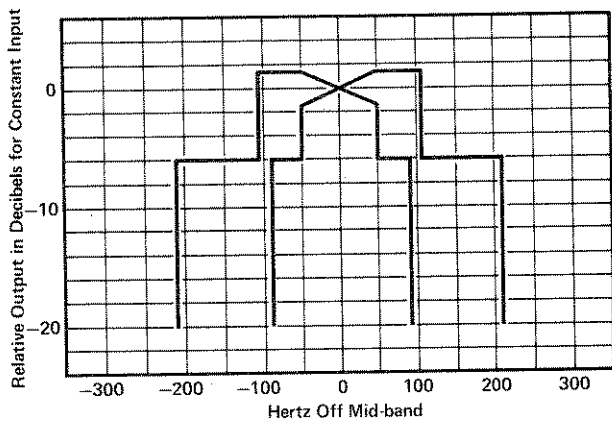

Figure 1. Limits of Overall Selectivity for Filter Having 200 Hz Resolution Bandwidth

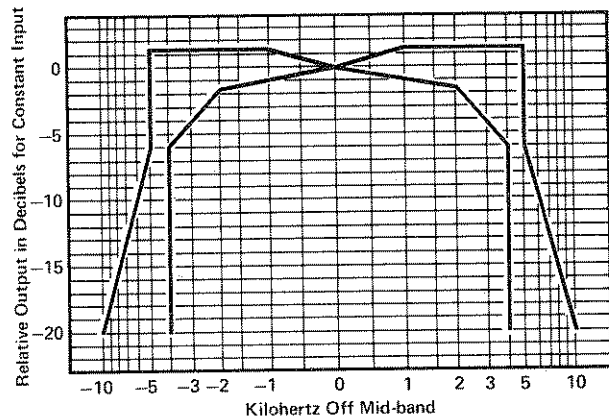

Figure 2. Limits of Overall Selectivity for Filter Having 9 kHz Resolution Bandwidth

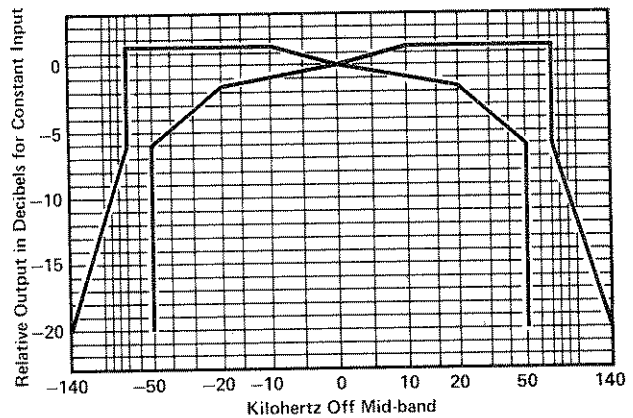

Figure 3. Limits of Overall Selectivity for Filter Having 120 kHz Resolution Bandwidth

FREQUENCY ACCURACY

Frequency uncertainty introduced by HP 85650A:

HP 85650A Instrument Function	With Spectrum Analyzer	HP 85650A Bandwidth		
		200 Hz	9 kHz	120 kHz
Bypass Mode	Uncorrected or Corrected ¹	0	0	0
Normal Mode	Uncorrected	±100 Hz	±4.5 kHz	±60 kHz

¹ Use KSW and KSX to perform correction routines for HP 8566A and HP 8568A.

AMPLITUDE SPECIFICATIONS

AMPLITUDE RESPONSE (with variation in pulse repetition frequency)²

Measurements are made on the spectrum analyzer with the HP 85650A connected and its instrument function in the NORMAL mode. The spectrum analyzer displays

² This specification was derived by combining Part 2.1, 'Amplitude relationship,' and Part 2.2, 'Variation with repetition frequency,' of CISPR Publication No. 16.

Table 1-1. HP Model 85650A Specifications (2 of 2)

the quasi-peak amplitude of a pulsed RF signal. The response is given as follows:

$$\text{quasi peak amplitude of test pulse} = \text{quasi peak CISPR pulse} + 20 \log \frac{V\tau}{(V\tau)_{\text{CISPR}}}$$

where V = peak amplitude (must be ≤ -10 dBm rms with 10 dB input atten.)

$$\tau = \text{pulse width (must be } < \frac{1}{3\text{BW}_{\text{HP 85650A}}})$$

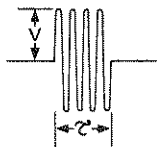

$(V\tau)_{\text{CISPR}} = 13.5 \mu\text{Vs for } 10\text{--}150 \text{ kHz}$
 $0.316 \mu\text{Vs for } .15\text{--}30 \text{ MHz}$
 $0.044 \mu\text{Vs for } .03\text{--}1 \text{ GHz.}$

Table 1. Amplitude Response

Quasi-Peak Amplitude of CISPR Pulse (dBμV)			
Pulse Repetition Frequency (Hz)	Frequency Band		
	10–150 kHz	.15–30 MHz	.03–1 GHz
1000	—	64.5 ± 2.5	68.0 ± 2.5
100	64.0 ± 2.5	60.0 ± 1.5	60.0 ± 1.5
60	63.0 ± 2.5	—	—
25	60.0 ± 1.5	—	—
20	—	53.5 ± 2.5	51.0 ± 2.5
10	56.0 ± 2.5	50.0 ± 3.0	46.0 ± 3.0
5	52.5 ± 3.0	—	—
2	47.0 ± 3.5	39.5 ± 3.5	34.0 ± 3.5
1	43.0 ± 3.5	37.5 ± 3.5	31.5 ± 3.5
Isolated Pulse	41.0 ± 3.5	36.5 ± 3.5	28.5 ± 3.5

CW AMPLITUDE ACCURACY

Increase in amplitude uncertainty introduced by HP 85650A:

Bypass Mode: ±0.3 dB
 Normal Mode: ±1.0 dB

GENERAL SPECIFICATIONS

TEMPERATURE RANGE:

Operating 0°C to 55°C
 Storage -40°C to +75°C

EMI:

Conducted and radiated interference characteristics are in compliance with methods CE03 and RE02 of MIL-STD 461A, VDE 0871 Level B, and CISPR Publication 11.

POWER REQUIREMENTS:

48 to 66 Hz; 100, 120, 220 or 240 volts (+5%, -10%); approximately 22 VA.

DIMENSIONS:

88.1 mm high, 425.5 mm wide, 558.5 mm deep (3.47 in. x 16.75 in. x 22 in.)

WEIGHT:

Net: 10 kg (22 lbs)
 Shipping: 15.5 kg (34 lbs)

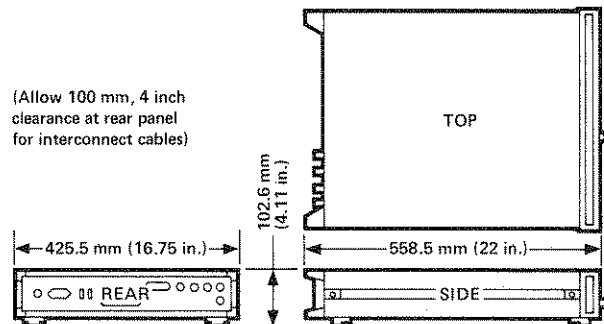

Table 1-2. HP 85650A Supplemental Characteristics

SUPPLEMENTAL CHARACTERISTICS

NOTE

Values in this table are not specifications but are typical characteristics included for user information.

FUNDAMENTAL CHARACTERISTICS

Nominal values for fundamental characteristics of the quasi-peak adapter are given in the following table:

Frequency Band (MHz)	Bandwidth at 6 dB (kHz)	Charge-Time Constant (ms)	Discharge-Time Constant (ms)	Meter Time Constant (ms)
.01-.15	.2	45	500	160
.15-30	9	1	160	160
20-1000	120	1	550	100

FREQUENCY ACCURACY

Frequency uncertainty is introduced by the quasi-peak adapter when the spectrum analyzer is in the corrected

mode (KSW and KSX). This uncertainty can be eliminated by following the procedure provided in Section III.

AUXILIARY SWITCHES

Nine Form C (SPDT) relays are used as auxiliary switches in the quasi-peak adapter. Six of these relays are multiplex switches which operate such that when one switch is in the ON state, the other five switches are in the OFF state. Three relays are independent switches, each of which operates in either the ON or OFF state independently of the other two. Contact rating is a maximum of 5A per relay at either 28 VDC or 115 VAC for a resistive load.

Table 1-3. Recommended Test Equipment

Instrument	Critical Specifications	Recommended Model	Use
Universal Counter	Frequency Resolution: 0.001 Hz for 1s gate time	HP 5315A	P
Pulse Generator	Pulse Amplitude: Maximum output $\geq 5V$ across 50Ω (variable) DC Offset: $\pm 2.5V$ Pulse Width: 1 μs to 10 ms (variable)	HP 8013B	P
Pulse Modulator	On/Off Ratio: 50 dB at 100 MHz	W-J S1*	P
Digital Multimeter	DC Voltmeter Accuracy: 0.1% of reading Ohmmeter Accuracy: 0.1% of reading	HP 3465A	T
Oscilloscope	Frequency: 100 MHz Sensitivity: 5.0 mV/div	HP 1740A	T
AC Probe	Frequency Response: ± 0.5 dB from 1 to 100 MHz Input Impedance: 100 kilohms, 3 PF shunt capacitance at 100 MHz	HP 1121A	T
Signature Analyzer	Clock Rate: 10 MHz	HP 5004A	T
Logic Pulser	Output Pulse Voltage: High $> 2.0V$ at 650 mA Low $< 0.8V$ at 650 mA	HP 546A	T
Current Tracer	Sensitivity: 1 mA to 1 A	HP 547A	T
Termination	Impedance: 50 Ohms Connector: BNC Male	HP 11593A	A
Adapter	Type N Male to BNC Female	HP 1250-0780	P, A, T
Adapter (2 required)	BNC Female to BNC Female	HP 1250-0080	P, A
BNC Tee	Connectors: 2 Female, 1 Male	HP 1250-0781	P
Cable Assembly (4 required)	Impedance: 50 Ohms Connectors: BNC Male, both ends Length: 61 cm (24 in.)	HP 11170B	P, A, T

*Watkins-Johnson Co., 333 Hillview Ave, Palo Alto, CA 94304

Table 1-4. Service Accessories, HP Part Number 85650-60051

Item	Qty	Description	HP Part Number	CD
1	1	Extender Board: 24 contacts; 2 rows of 12	08559-60042	2
2	1	Test 1 Jumper	85650-60052	8
3	1	Test 2 Jumper	85650-60053	9

SECTION II INSTALLATION

2-1. INTRODUCTION

2-2. This section includes information about the initial inspection, preparation for use, storage, and shipment of the HP Model 85650A Quasi-Peak Adapter.

2-3. INITIAL INSPECTION

2-4. Inspect the shipping container for damage. If the shipping container or cushioning material is damaged, it should be kept until the contents of the shipment have been checked for completeness and the instrument has been checked mechanically and electrically.

2-5. The contents of the shipment should be as shown in Figure 1-1. Procedures to verify normal operation are contained in Section IV, Performance Tests.

2-6. If the contents of the shipment are incomplete, if there is mechanical damage or defect, or if the HP 85650A exhibits an electrical malfunction, notify the nearest Hewlett-Packard office. If the shipping container is damaged, or the cushioning material shows signs of stress, notify the carrier as well as the Hewlett-Packard office. Keep the shipping materials for inspection by the carrier. The HP office will arrange for repair or replacement without waiting for a claim settlement.

2-7. PREPARATION FOR USE

WARNING

Operator personnel must not remove protective covers from either the spectrum analyzer or the quasi-peak adapter. Since there are dangerous voltages inside these instruments, their covers must be removed ONLY by qualified

maintenance service personnel who are aware of the hazards involved.

2-8. Modification to Spectrum Analyzer for Use of Quasi-Peak Adapter

2-9. Operation of the HP 85650A Quasi-Peak Adapter requires interconnection with either the HP 8566A or HP 8568A Option 650 Spectrum Analyzer. A modification kit, HP Part Number 85650-60050, is available for field installation of Option 650. This kit, which can be ordered through any Hewlett-Packard office, contains all parts required for the modification, including hardware and instructions. Service Notes 8566A-15 and 8568A-39, which are included in the kit, provide detailed installation instructions. HP 8568A Spectrum Analyzers with IF-Display Sections whose serial prefixes are 1745A and below require additional modifications described in Service Note 8568A-40.

2-10. Operating Environment

2-11. Environmental limitations for the 85650A are:

Temperature: The instrument may be operated from 0°C to +55°C. The instrument may be stored or shipped from -40°C to +75°C.

Altitude (Barometric): The instrument may be operated at altitudes up to 4572 meters (15,000 feet). The instrument may be stored or shipped up to 15240 meters (50,000 feet).

2-12. Power Requirements

2-13. The HP 85650A requires a power source of 100, 120, 220, or 240 Vac +5% - 10%, 48 to 66 Hz, single phase. Power consumption is less than 22 volt-amperes.

2-14. Line Voltage and Fuse Selection

WARNING

BEFORE THIS INSTRUMENT IS SWITCHED ON, its protective earth terminals must be connected to the protective conductor of the mains power cable (cord). The mains power cable plug shall be inserted only in a socket outlet that is provided with a protective earth contact. DO NOT defeat the earth-grounding protection by using an extension cable, a power cable, or an autotransformer without a protective ground conductor. Failure to ground the instrument properly can result in serious personal injury.

CAUTION

BEFORE SWITCHING ON THIS INSTRUMENT, make sure it is adapted to the voltage of the ac power source. You must correctly set the 85650A rear-panel voltage selector switches to adapt the 85650A to the power source. Failure to set the ac power input of the instrument for the correct voltage level could cause damage to the instrument when it is switched on.

2-15. Select the line voltage and fuse as follows:

1. Measure the ac line voltage.

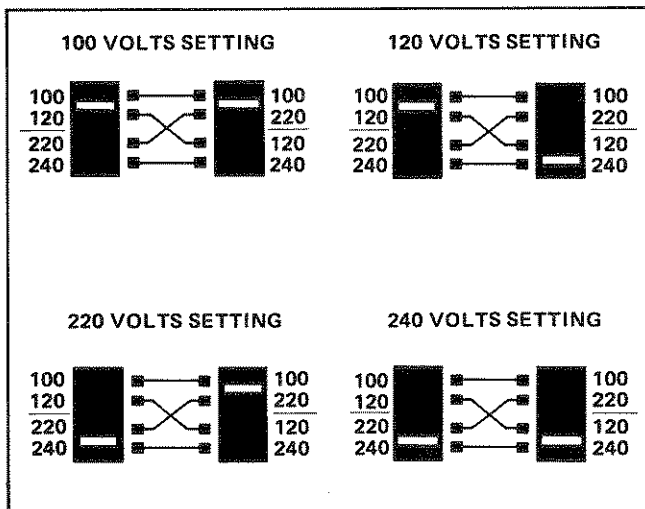

Figure 2-1. AC Voltage Selector Switch Positions

2. See Figure 2-1. Set rear-panel ac power level switches to select line voltage (100V, 120V, 220V, 240V) closest to voltage measured in step 1. Line voltage must be within +5% or -10% of voltage setting. If line voltage is not within limits, an autotransformer must be connected between ac source and HP 85650A. Table 2-2 shows the styles of plugs available on ac power cables supplied with HP instruments.
3. Make sure correct fuse is installed in fuse holder. Required fuse rating depends on ac line voltage, and is indicated next to fuse holder and in following table. Part numbers for replacement fuses are located in Section VI, Replaceable Parts.

Voltage	Quasi-Peak Adapter
100/120	750 mA FAST BLO
220/240	500 mA FAST BLO

2-16. HP-IB Address Selection

2-17. The HP-IB address for the HP 85650A is preset at the factory for address 17. (This decimal value corresponds to a talk address of Q and a listen address of 1.) The HP-IB address label (Figure 2-2) is a convenient way to note this. Figure 2-3 shows the HP-IB address switch in its preset position. The addresses listed in Table 2-1 can be selected by setting the five segments of the HP-IB address switch, located on the rear panel, to correspond to the five-bit binary equivalent of the desired device address. If the HP-IB settings are changed while the instrument is on, ac power must be removed, then reapplied to activate new settings.

2-18. HP-IB address labels may be obtained by ordering HP Part Number 7120-6853. These labels allow easy reference to the HP-IB address of each system component.

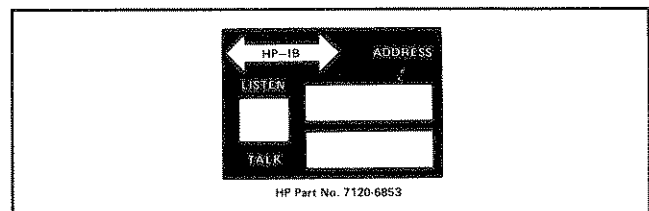

Figure 2-2. HP-IB Address Label

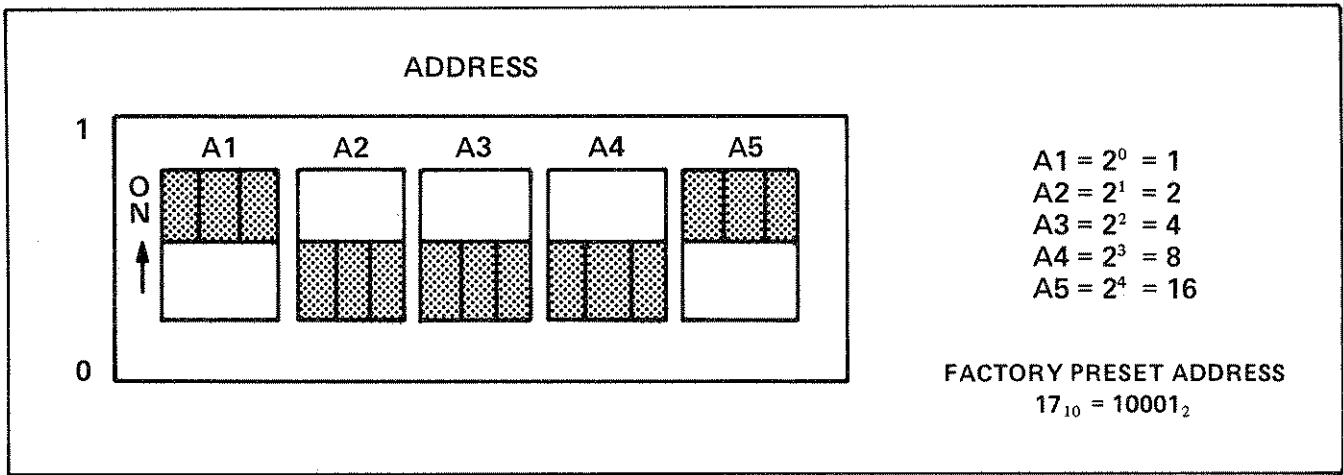
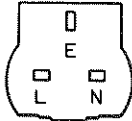
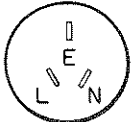
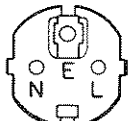

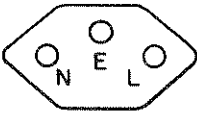
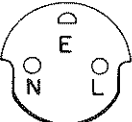

Figure 2-3. HP-IB Address Switch

Table 2-1. Cross Reference Between Decimal and Binary Address Codes

DEVICE ADDRESS DECIMAL VALUE	5-BIT BINARY EQUIVALENT	TALK ADDRESS	LISTEN ADDRESS
00	00000	@	SP
01	00001	A	!
02	00010	B	"
03	00011	C	#
04	00100	D	\$
05	00101	E	%
06	00110	F	&
07	00111	G	'
08	01000	H	(
09	01001	I)
10	01010	J	*
11	01011	K	+
12	01100	L	,
13	01101	M	-
14	01110	N	.
15	01111	O	/
16	10000	P	∅
17	10001	Q	1
18	10010	R	2
19	10011	S	3
20	10100	T	4
21	10101	U	5
22	10110	V	6
23	10111	W	7
24	11000	X	8
25	11001	Y	9
26	11010	Z	:
27	11011	[;
28	11100	\	<
29	11101]	=
30	11110	(>

Table 2-2. AC Power Cables and Plugs

Plug Type	HP Part Number	C D	Plug Description	Length cm (inches)	Color	Country of Use
250V 	8120-1351 8120-1703	0 6	Straight *BS1363A 90°	229 (90) 229 (90)	Mint Gray Mint Gray	United Kingdom, Cyprus, Nigeria, Rhodesia, Singapore, South Africa, India
250V 	8120-3169 8120-0696	0 4	Straight *NZSS198/ASC112 90°	201 (79) 221 (87)	Gray Gray	Australia, New Zealand
250V 	8120-1689 8120-1692	7 2	Straight *CEE7-Y11 90°	201 (79) 201 (79)	Mint Gray Mint Gray	East and West Europe, Saudi Arabia, Egypt, South Africa, India, (unpol- arized in many nations)
125V 	8120-1348 8120-1398 8120-1754 8120-1378 8120-1521 8120-1676	5 5 7 1 6 2	Straight *NEMA5-15P 90° Straight *NEMA5-15P Straight *NEMA5-15P 90° Straight *NEMA5-15P	203 (80) 203 (80) 91 (36) 203 (80) 203 (80) 91 (36)	Black Black Black Jade Gray Jade Gray Jade Gray	United States, Canada, Japan (100V or 200V), Mexico, Philip- pines, Taiwan
250V 	8120-2104	3	Straight *SEV1011 1959-24507 Type 12	201 (79)	Gray	Switzerland
220V 	8120-1957 8120-2956	2 3	Straight *DHCK 107 90°	201 (79) 201 (79)	Gray Gray	Denmark

*Part number shown for plug is industry identifier for plug only. Number shown for cable is HP Part Number for complete cable including plug.

E = Earth Ground; L = Line; N = Neutral

2-19. Bench Use

2-20. For ease of operation, position the HP 85650A Quasi-Peak Adapter on top of the spectrum analyzer. To lock the HP 85650A and the spectrum analyzer together, perform the following steps:

1. Remove front frame top trim from the spectrum analyzer (see Figure 2-4).

CAUTION

When attaching the lock links, use of screws other than those provided might cause damage to the instrument, resulting in costly repair. These screws are 6-32 thread and 0.188 inch long. If replacement of these screws is necessary, be sure replacement does not exceed specified length.

2. Fasten four lock links, supplied with instrument, to HP 85662A front frame. Use eight 6-32 pozidriv screws provided (there are eight threaded holes in front frame). Open end of each lock link must extend toward front of HP 85662A as shown in Figure 2-4.

3. Interchange two top rear lock feet on HP 85650A with two top rear feet of HP 85662A (Figure 2-5). Remove four plastic feet from bottom cover of HP 85650A.
4. Set HP 85650A on top of spectrum analyzer with front edge of HP 85650A overhanging front edge of spectrum analyzer by approximately 0.5 inch (1.3 cm).
5. Slide HP 85650A back until its front edge is even with front edge of the spectrum analyzer. Fronts of both instruments should now be locked together. Make sure they are securely locked by carefully lifting front of HP 85650A.
6. Tighten thumb screws on rear lock feet of HP 85650A into rear lock feet of spectrum analyzer.

2-21. Front Handles

- 2-22. Instruments are shipped with a Front Handle Kit which supplies necessary hardware, with installation instructions, for mounting front handles on the instrument. Installation instructions are also given in Figure 2-6.

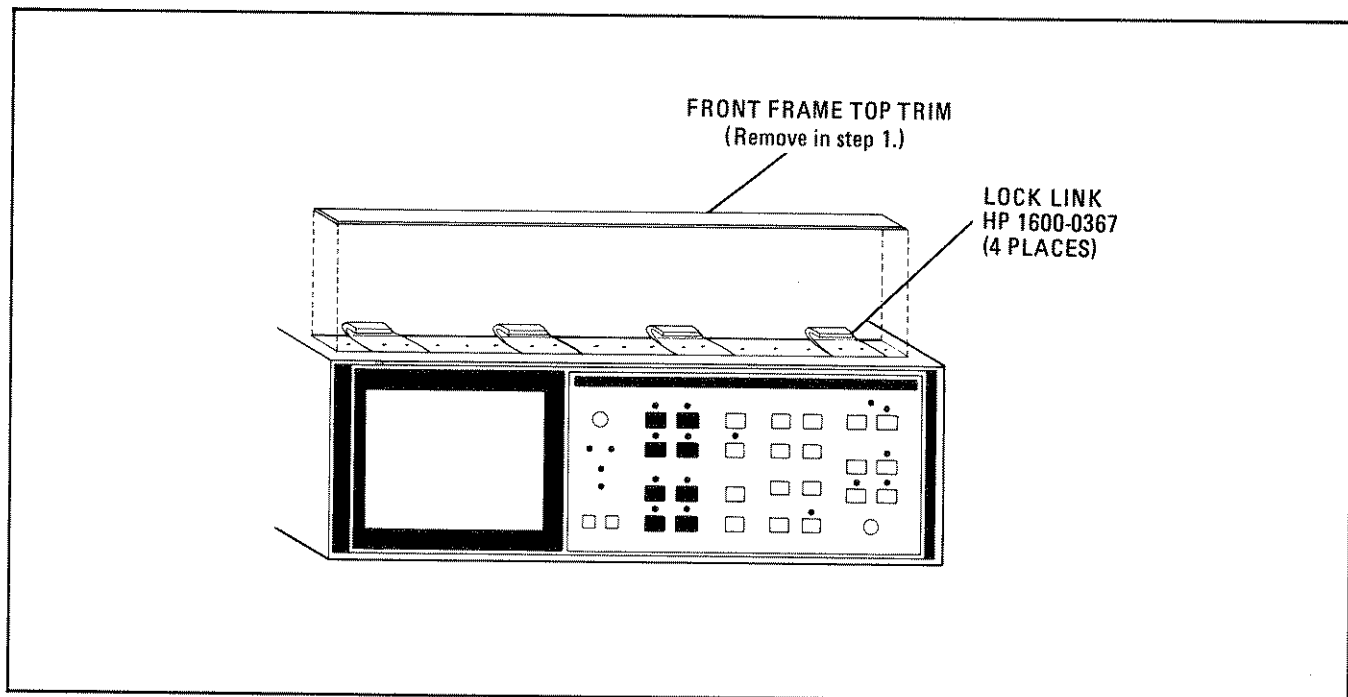

Figure 2-4. Installation of Lock Links on Spectrum Analyzer

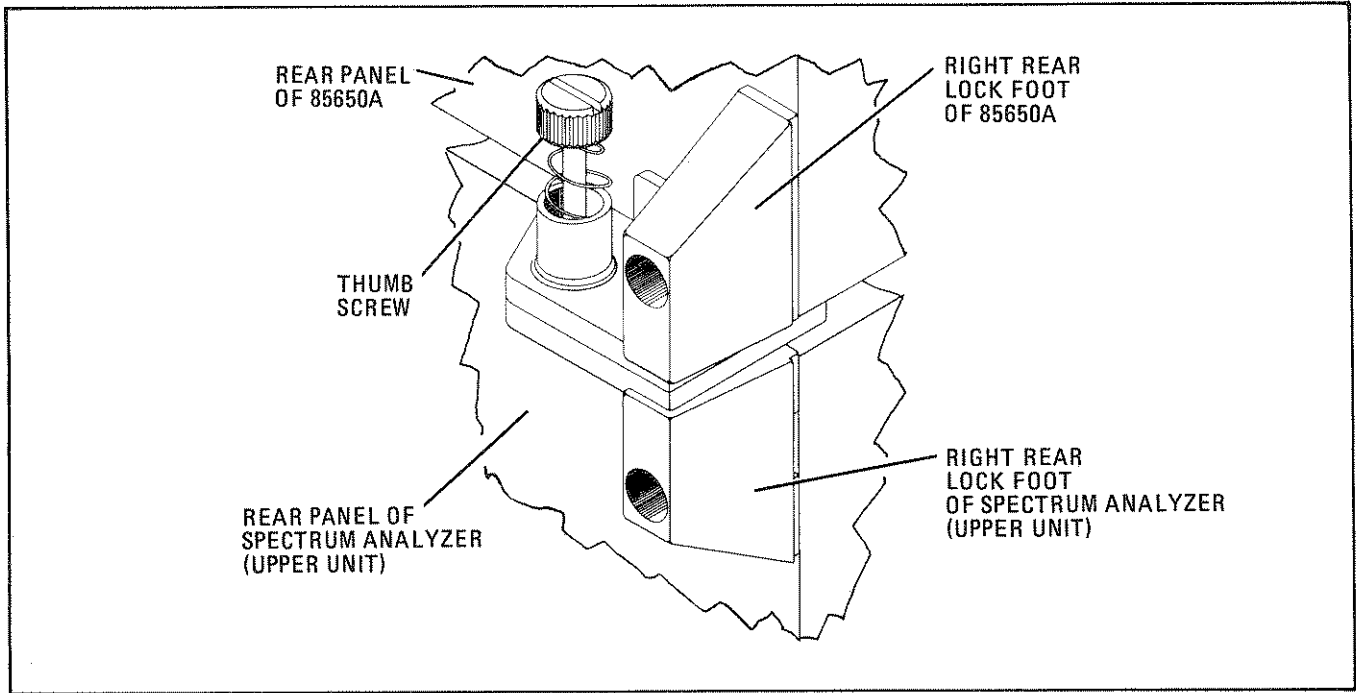

Figure 2-5. Installation of Lock Feet

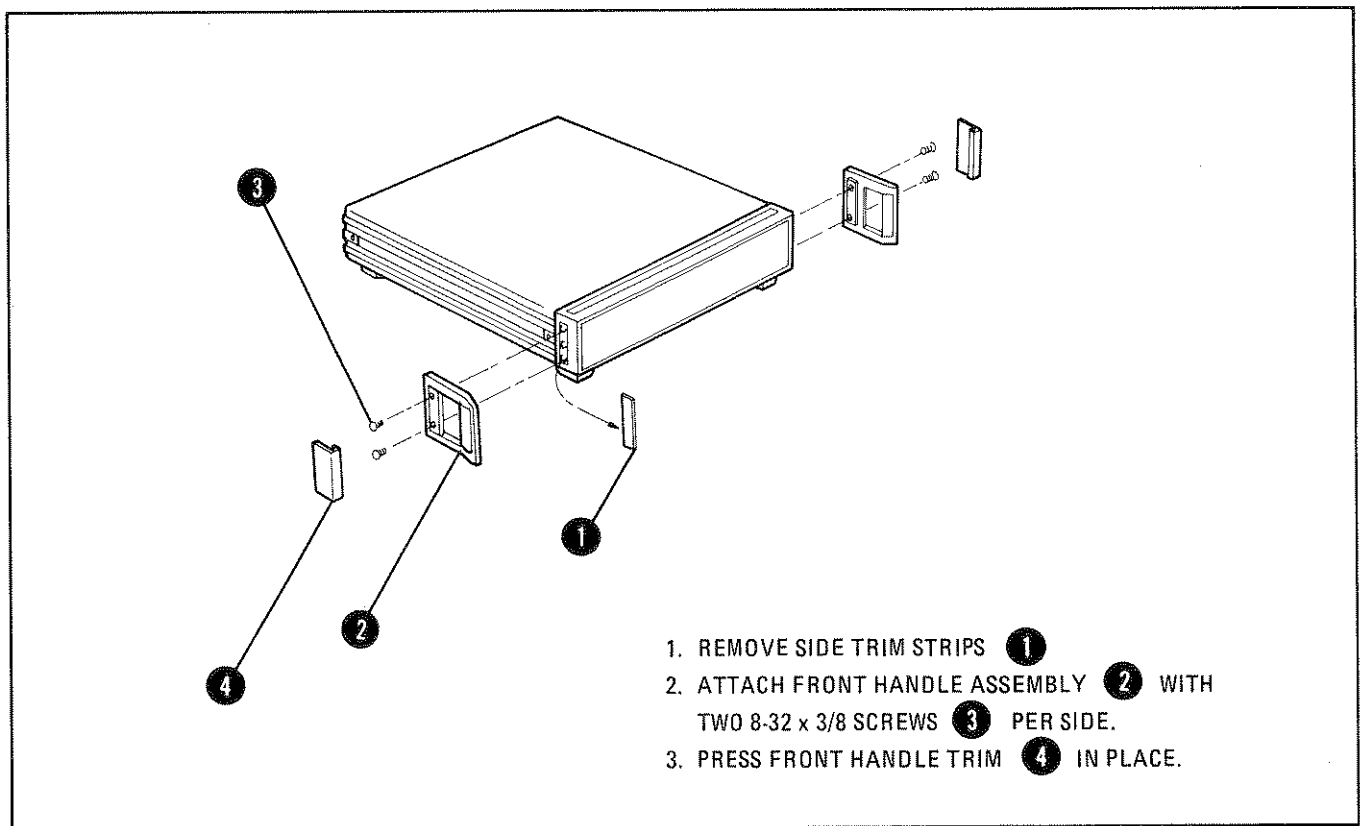

Figure 2-6. Installation of Front Handles

2-23. Rack Mounting (Options 908 and 913)

2-24. Instruments with Option 908 are shipped with a Rack Flange Kit, which supplies necessary hardware, with installation instructions, for mounting the instrument on a rack whose spacing is 482.6 mm (19 inches). Installation instructions are also given in Figure 2-7. Refer to Table 2-3 for HP part numbers.

2-25. Instruments with Option 913 are shipped with a Rack Flange and Front Handle Kit, which supplies necessary hardware, with installation instructions, to add front handles and to mount the instrument on a rack, whose spacing is 482.6 mm (19 inches). Installation instructions are also given in Figure 2-8. Refer to Table 2-3 for HP part numbers.

2-26. Cable Connections

2-27. Interconnect Cables. Four coaxial cables with BNC connectors are required for interconnecting the spectrum analyzer and the quasi-

peak adapter. See Figure 2-9. These cables should be connected as indicated in the following table.

Quasi-Peak Adapter	Spectrum Analyzer
21.4 MHz INP (J3)	IF OUT
21.4 MHz OUT (J4)	IF INP
QUASI-PEAK DETECTOR INP (J5)	VIDEO OUT
QUASI-PEAK DETECTOR OUT (J6)	VIDEO INP

2-28. If necessary connectors are not present on the spectrum analyzer, a modification to the analyzer is required to allow use of the quasi-peak adapter. This modification is described in the paragraph entitled 'Modification to Spectrum Analyzer for Use of Quasi-Peak Adapter.'

2-29. Auxiliary Switches Control. The auxiliary switches of the HP 85650A can be used in conjunction with an external power supply to control remote RF coaxial switches. (See Figure 2-10.)

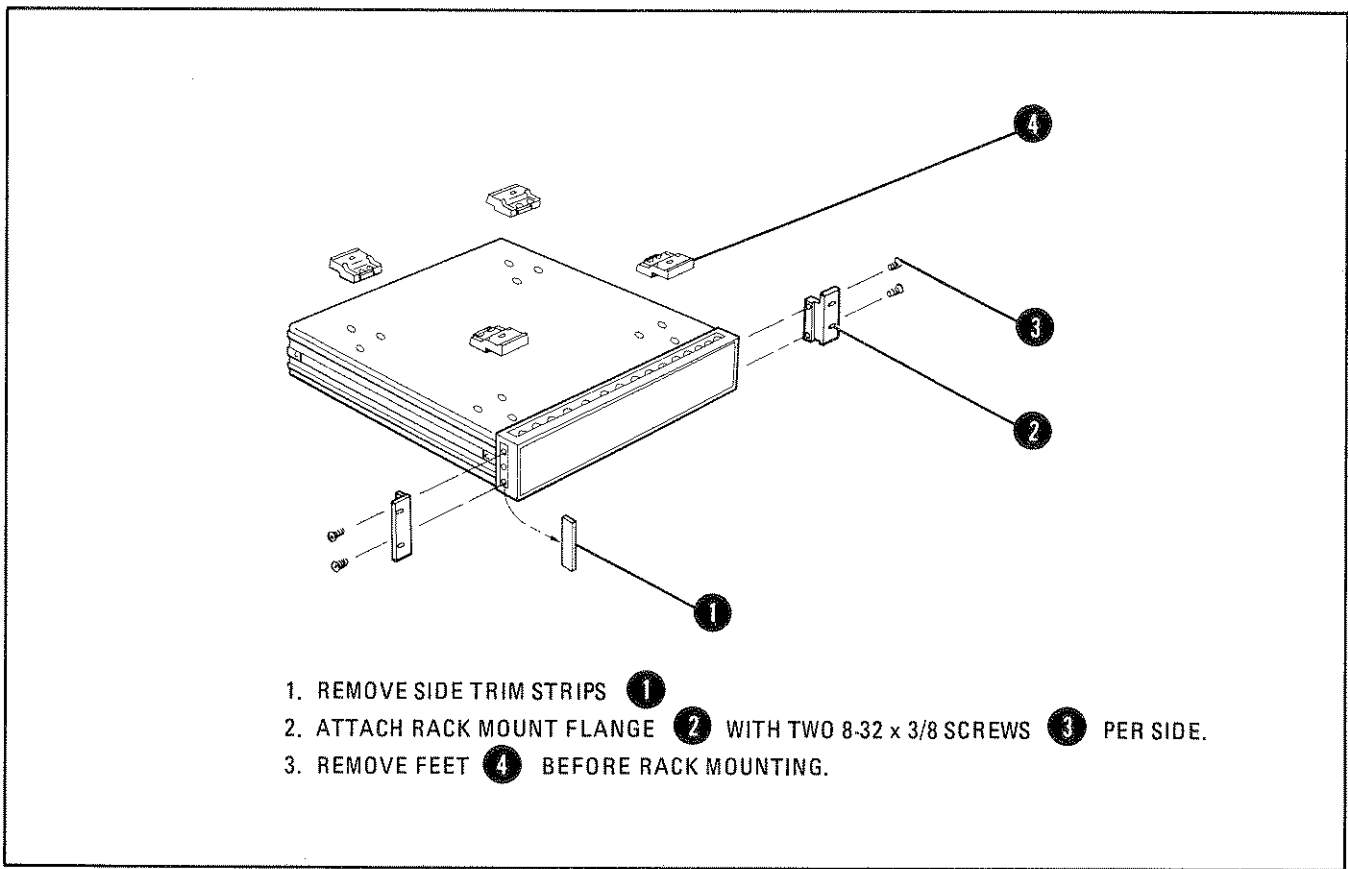

Figure 2-7. Installation of Rack-Mounting Hardware without Front Handles

These RF coaxial switches can then be used to permit auxiliary devices such as preamplifiers, attenuators, filters, and antennas to be switched in and out of the measurement system. The auxiliary switch should have a maximum resistive load of 5A per relay at either 28 VDC or 115 VAC. Auxiliary switch functions and connections are described in Section III of this Operation and Service Manual.

2-30. Mating Connectors. The mating connector for Auxiliary Switches connector A6A1J2

can be ordered from any Hewlett-Packard office as HP Part Number 1251-0084. This 57 series, 36-pin, Micro-Ribbon connector is also available from Amphenol Sales Division of Bunkeramo and from TRW Elek Components, Cinch Division.

2-31. Power Cables. In accordance with international safety standards, this instrument is equipped with a three-wire ac power cable. When connected to an appropriate power line outlet, this cable grounds the instrument cabinet. Table 2-2

Table 2-3. Rack-Mount Kits for HP 85650A

Description	CD	HP Part Number	Quantity
OPTION 908			
Rack-Mount Flange	4	5020-8934	2
Machine Screw, Pan Head, 8-32 x 0.375 inch	7	2510-0193	4
OPTION 913			
Rack-Mount Flange	5	5020-8935	2
Machine Screw, Pan Head, 8-32 x 0.625 inch	8	2510-0194	4

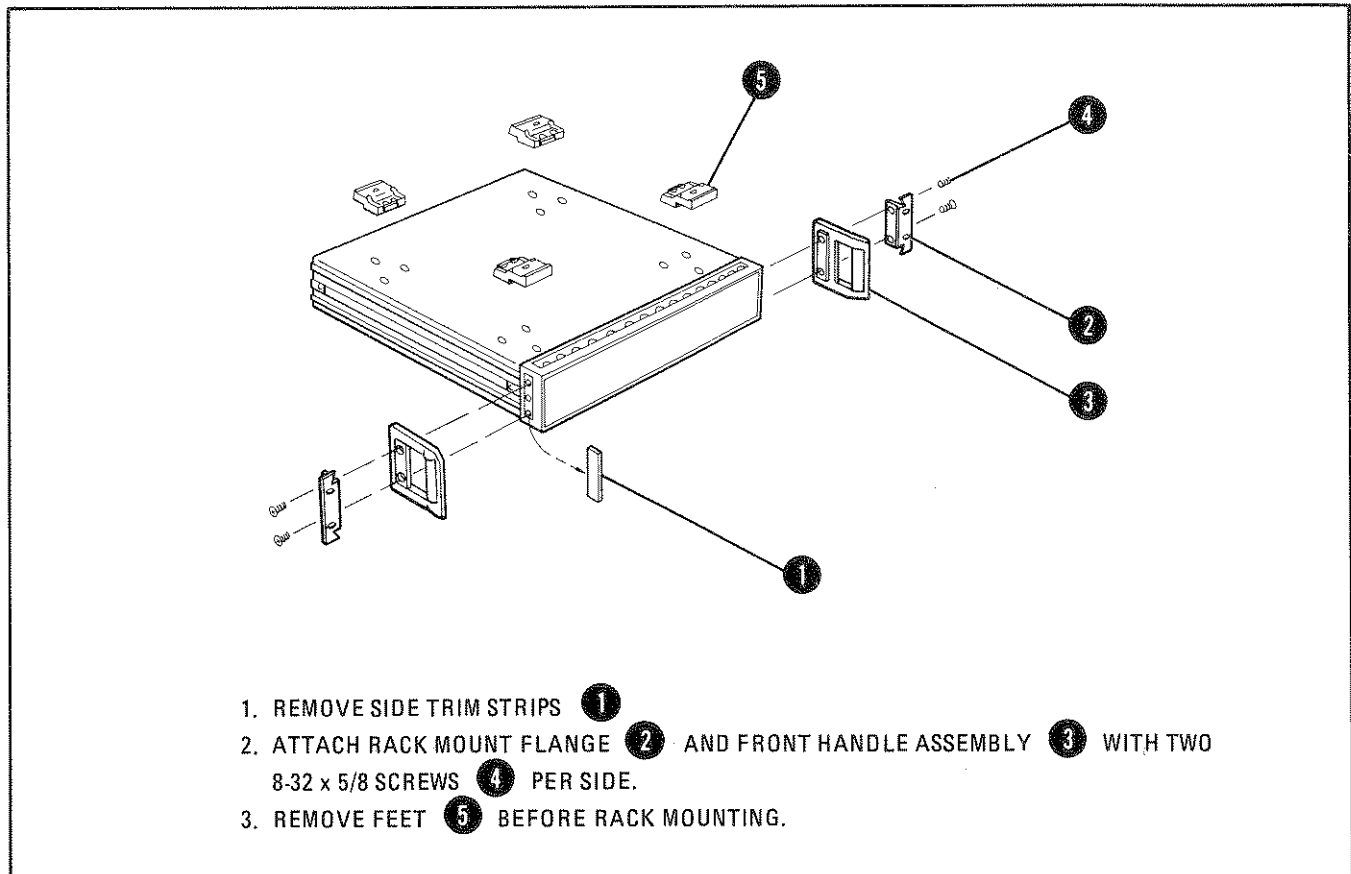

Figure 2-8. Installation of Rack-Mounting Hardware with Front Handles Supplied

shows the styles of plugs available on ac power cables supplied with HP instruments. The numbers for the plugs are part numbers for complete ac power cables.

WARNING

If this instrument is to be energized through an autotransformer, make sure the common terminal of the autotransformer is connected to the protective earth contact of the power source outlet socket.

2-32. SHIPMENT

2-33. Packaging

2-34. Original Packaging. Containers and materials identical to those used in factory packaging are available through Hewlett-Packard offices.

Figure 2-11 illustrates the proper method of packaging the instrument for shipment using factory packaging materials.

2-35. If the instrument is being returned to Hewlett-Packard for servicing, attach a tag to the carton indicating type of service required, return address, model number, and full serial number. A supply of tags is provided at the end of this section. Also, mark the container FRAGILE to assure careful handling. In any correspondence, refer to the instrument by model number and full serial number.

2-36. Other Packaging. The following general instructions should be used for repackaging with commercially available materials:

1. Wrap the instrument in heavy paper or plastic. If shipping to a Hewlett-Packard of-

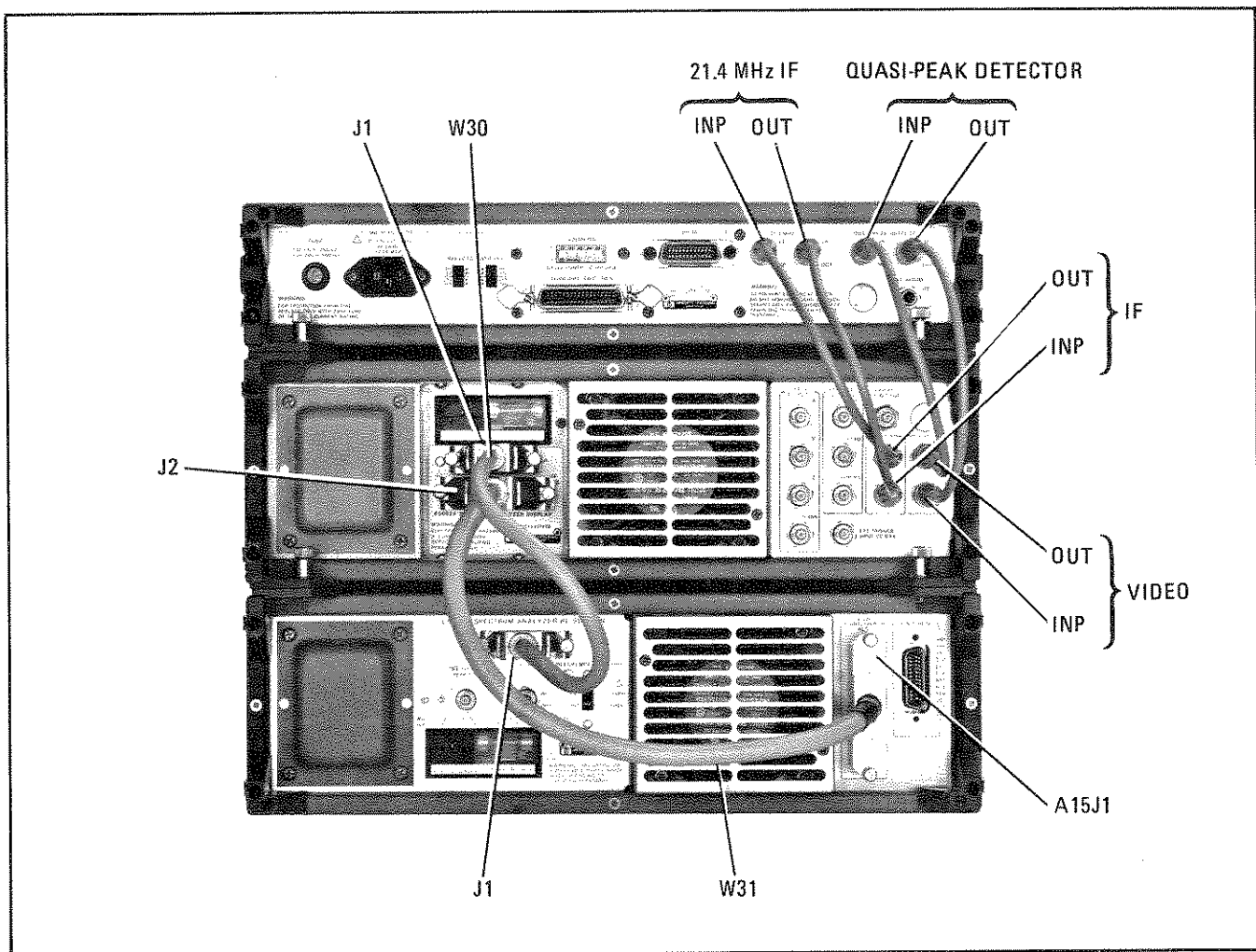

Figure 2-9. HP 85650A Cable Connections

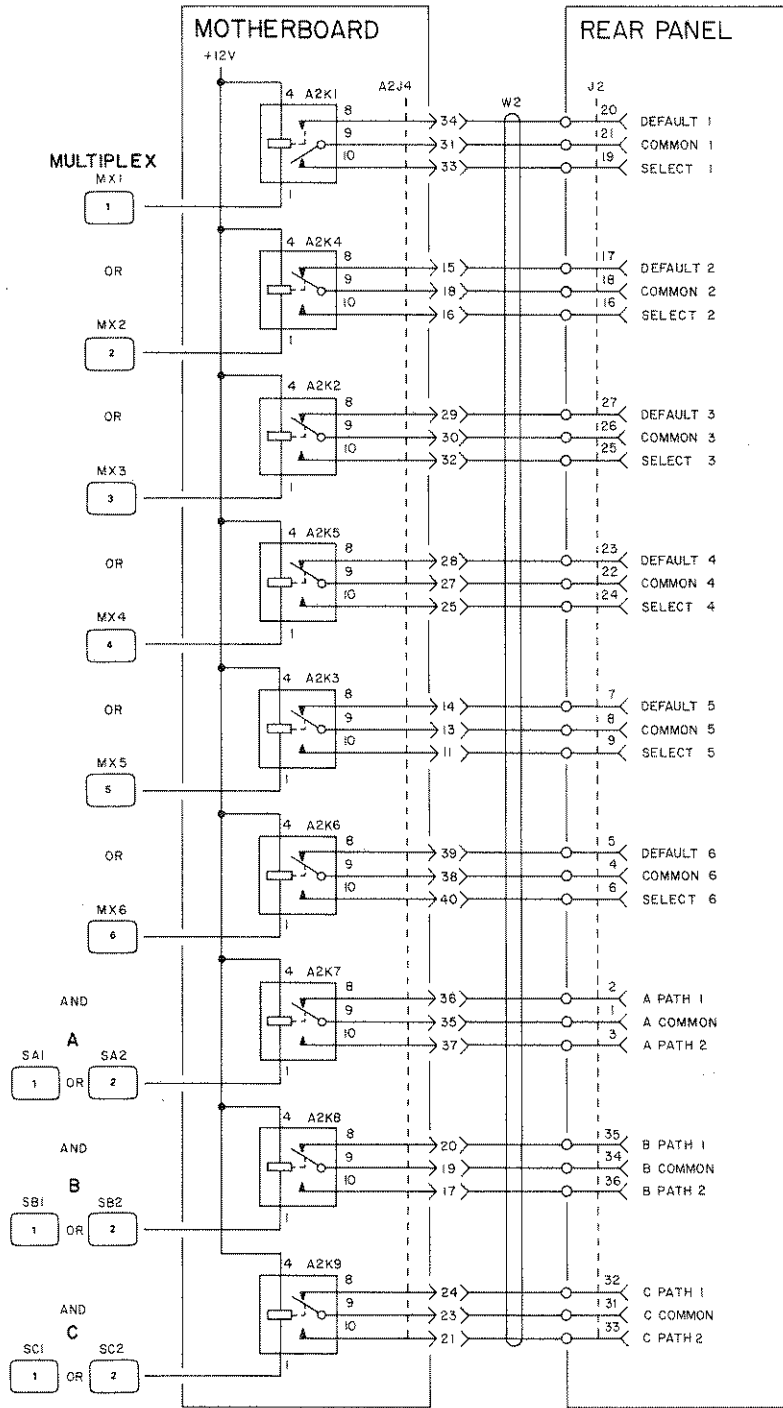

Figure 2-10. Connection Diagram for Auxiliary Switches Function

office or service center, attach a tag indicating type of service required, return address, model number, and full serial number. A supply of these tags is provided at the end of this section.

2. Place the instrument in a container with 8 to 10 cm (3 to 4 inches) of shock-absorbing material around all sides to provide firm cushioning and prevent movement inside the

container. Protect front panels with cardboard. A double-wall corrugated carton of 125 kg (275 lb.) bursting strength is sufficient for a shipping container.

3. Seal the shipping container securely.
4. Mark the shipping container FRAGILE to assure careful handling.

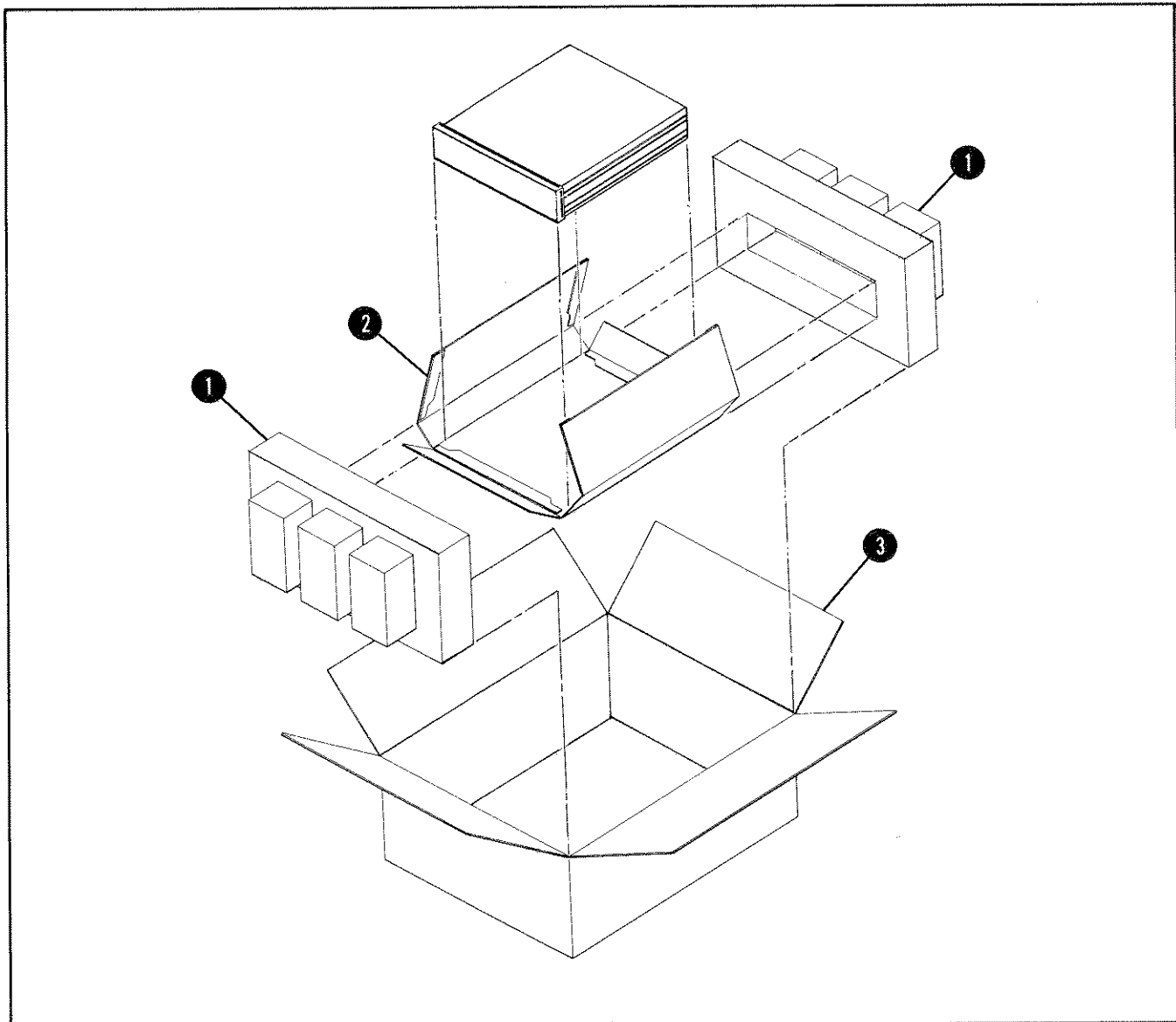

Item	Qty	HP Part Number	CD	Description
①	2	9220-2807	6	END, PAD, POLYURETHANE FOAM
②	1	9220-2808	7	INNER CARTON, CORRUGATED PAD
③	1	9211-2752	1	OUTER CARTON, CORRUGATED, DOUBLE WALL

Figure 2-11. Factory Packaging



SECTION III OPERATION

3-1. INTRODUCTION

This manual section contains information regarding both manual and remote operation of the HP 85650A. The information in this section is divided into four subsections as follows:

OPERATING THE HP 85650A. Detailed functional description of each front-panel control with corresponding HP-IB programming code.

MEASUREMENT PROCEDURES. Detailed procedures for performing both conducted and radiated emissions measurements.

MEASUREMENT CONSIDERATIONS AS RELATED TO SPECTRUM ANALYZER OPERATION. Items to be considered when using the HP 85650A/8566A or HP 85650A/8568A measurement system for EMI measurements.

HP-IB REMOTE OPERATION. Detailed operation instructions for using the HP 85650A with a remote controller via the HP-IB.

Additional information concerning the use of the quasi-peak adapter/spectrum analyzer system can be found in Product Note 85650A-1 (HP Part Number 5952-9364) available from any Hewlett-Packard office. In addition to the four topics listed above, Product Note 85650A-1 covers the following topics:

- Introduction to the quasi-peak measurement of electromagnetic interference.
- Potential system limitations
- Measurement system configurations
- Characteristics of the quasi-peak receiver
- Measurement considerations as they relate to potential system limitations

3-2. OPERATING THE HP 85650A

3-3. Getting Started

To form a complete measuring system, the HP 85650A Quasi-Peak Adapter must be interconnected with either an HP 8568A Option 650 RF Spectrum Analyzer or an HP 8566A Option 650 Microwave Spectrum Analyzer. Refer to Section II for instructions on interconnection, modification of analyzer to incorporate Option 650, and also for information on power requirements and HP-IB address selection.

3-4. Detailed Operation

This section describes the function selected by each of the front-panel controls. Each of these functions except LINE and AUDIO VOLUME, is also controllable via the HP-IB (Hewlett-Packard Interface Bus). The applicable programming code for each function is given in parentheses following the manual control name. Refer to HP-IB Remote Operation in this section for further information concerning the use of the HP-IB for instrument programming using a remote controller.

Instrument Preset

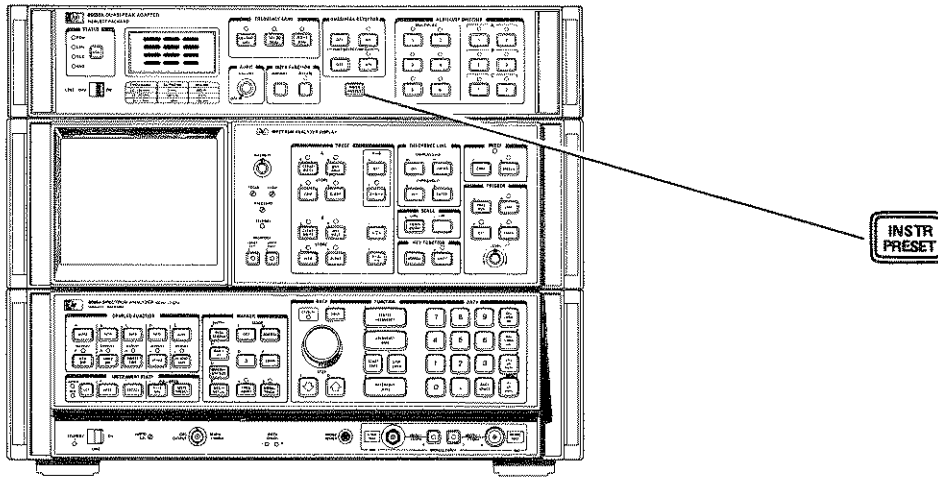

INSTR PRESET

(IP) provides a convenient starting point for making most measurements. This function presets each of the instrument controls to a predetermined condition. The functions selected by **INSTR PRESET** (IP) are:

- | | | |
|---------------------------|--|-------|
| FREQUENCY BAND | <input checked="" type="checkbox"/> 03-1 GHz | (FR3) |
| INSTR FUNCTION | <input type="checkbox"/> BYPASS | (BP) |
| QUASI-PEAK DETECTOR | <input type="checkbox"/> OFF | (Q0) |
| POST DETECTION GAIN | <input type="checkbox"/> OFF | (A0) |
| AUXILIARY SWITCHES | | |
| MULTIPLEX | <input checked="" type="checkbox"/> 1 | (MX1) |
| A | <input checked="" type="checkbox"/> 1 | (SA1) |
| B | <input checked="" type="checkbox"/> 1 | (SB1) |
| C | <input checked="" type="checkbox"/> 1 | (SC1) |

Instrument Function

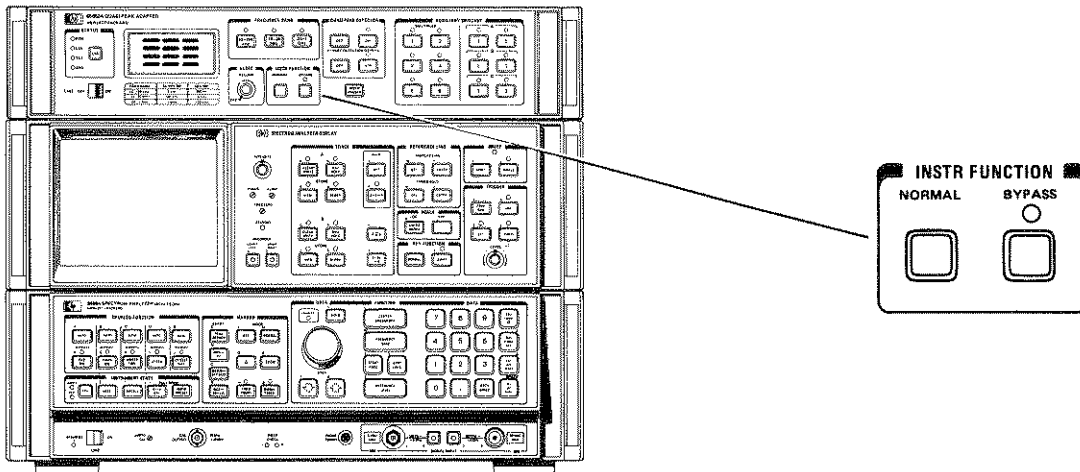

Instrument Functions that can be selected:

- NORMAL** (NM). Allows use of the quasi-peak adapter bandwidths and quasi-peak detector with the spectrum analyzer.
- BYPASS** (BP). Allows use of the spectrum analyzer unaffected by the quasi-peak adapter by bypassing both the bandwidth filters and quasi-peak detector.

An illuminating indicator accompanying the BYPASS pushbutton indicates current instrument function selection.

Normal. With NORMAL (NM) function selected, one of three quasi-peak adapter bandwidths is selected for use. The quasi-peak detector can be used in this and only this function.

Bypass. The BYPASS function is used to bypass or eliminate the quasi-peak adapter from the measurement system. This allows the spectrum analyzer to be used in a conventional manner unaffected by the addition of the quasi-peak adapter. If previously activated, both the bandwidth filter and quasi-peak detector remain activated even though they are bypassed (not in the measurement system).

Frequency Band

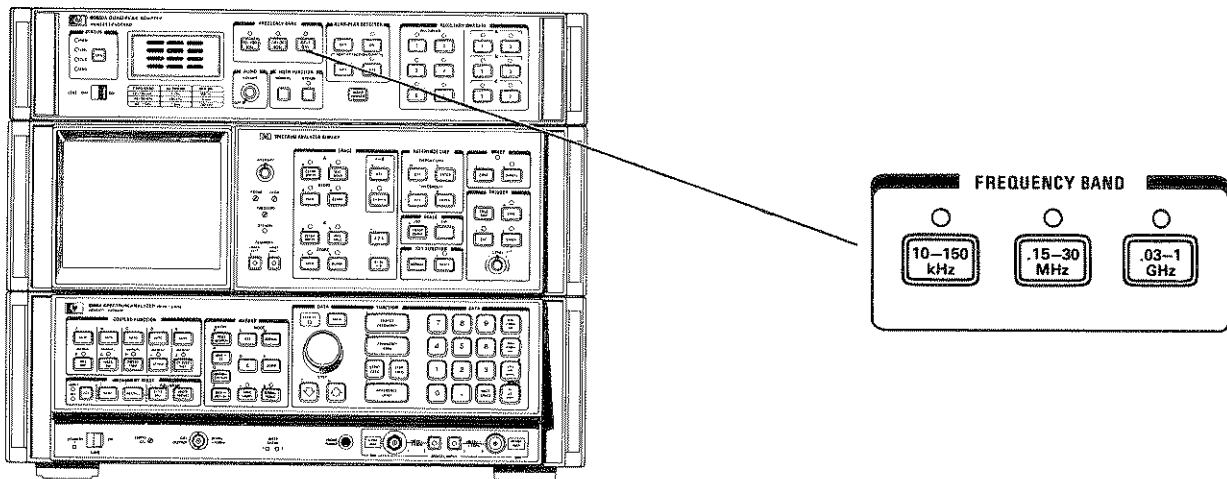

- 10-150 kHz** (FR1) Frequency Band 1 (CISPR Band A). Selects 200 Hz quasi-peak adapter bandwidth; usually used in 10-150 kHz frequency range for EMI testing.
- .15-30 MHz** (FR2) Frequency Band 2 (CISPR Band B). Selects 9 kHz quasi-peak adapter bandwidth; usually used in 150 kHz-30 MHz frequency range for EMI testing.
- .03-1 GHz** (FR3) Frequency Band 3 (CISPR Band C/D). Selects 120 kHz quasi-peak adapter bandwidth; usually used in 30 MHz-1 GHz frequency range for EMI testing.

An illuminating indicator accompanying each FREQUENCY BAND pushbutton indicates current quasi-peak adapter bandwidth selection.

For proper operation, the spectrum analyzer resolution bandwidth must be selected to be approximately 10 times the quasi-peak adapter bandwidth. The proper bandwidth to be used for each Frequency Band is indicated in the table on the front panel of the quasi-peak adapter illustrated below. Spectrum analyzer video bandwidth should be selected to be equal to spectrum analyzer resolution bandwidth.

FREQ BAND	SA RES BW	QPA BW
10–150 kHz	3 kHz	200 Hz
.15–30 MHz	100 kHz	9 kHz
.03–1 GHz	1 MHz	120 kHz

Quasi-Peak Detector

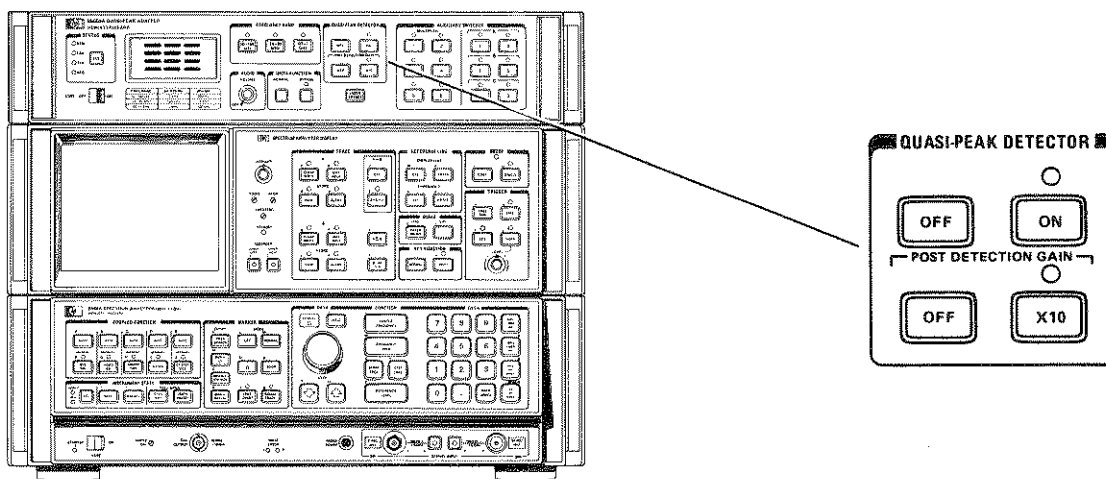

QUASI-PEAK DETECTOR

- (Q0) Routes signal around quasi-peak detector.
- (Q1) Routes signal through quasi-peak detector.

POST DETECTION GAIN

- (A0) Turns post-detection amplifier off to provide gain of 1.
- (A1) Turns post-detection amplifier on to provide gain of 10 (20 dB).

Quasi-Peak Detector. The quasi-peak detector can be turned on or off independent of the quasi-peak adapter bandwidth filters as selected by the FREQUENCY BAND pushbuttons. This peak detector provides the charging, discharging, and display time constants required for quasi-peak EMI measurements. The quasi-peak detector is bypassed (even if enabled) when BYPASS is selected.

Post Detection Gain. The post-detection amplifier provides 20 dB gain for use with low level signals. Since this amplifier is located in the same signal path as the peak detector, the QUASI-PEAK DETECTOR (Q1) function must be selected to use this amplifier.

Audio Control and Speaker

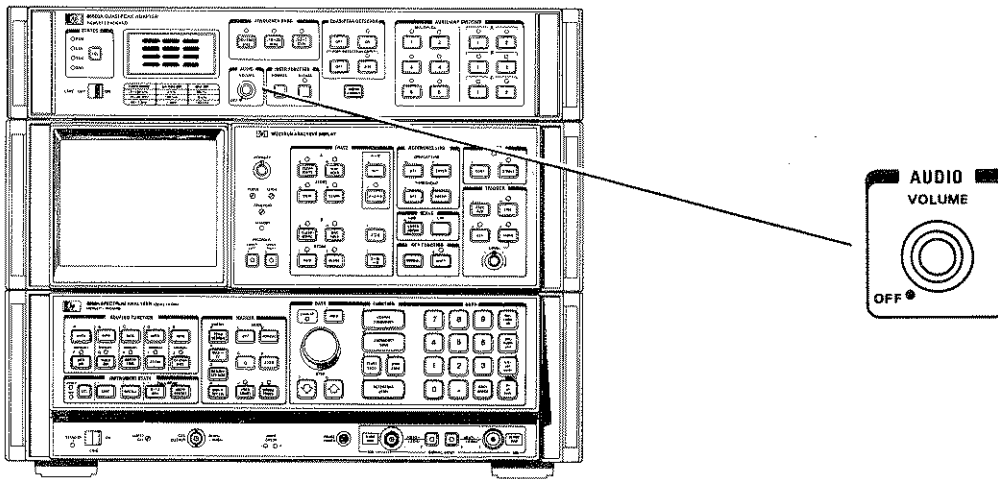

The quasi-peak adapter is provided with an internal speaker to aid in the identification of signals under investigation. A volume control with OFF position is provided for convenience.

A rear-panel external audio connector is also provided to allow the use of an external speaker or headset. The internal speaker is disabled when the external connection is used.

Auxiliary Switches

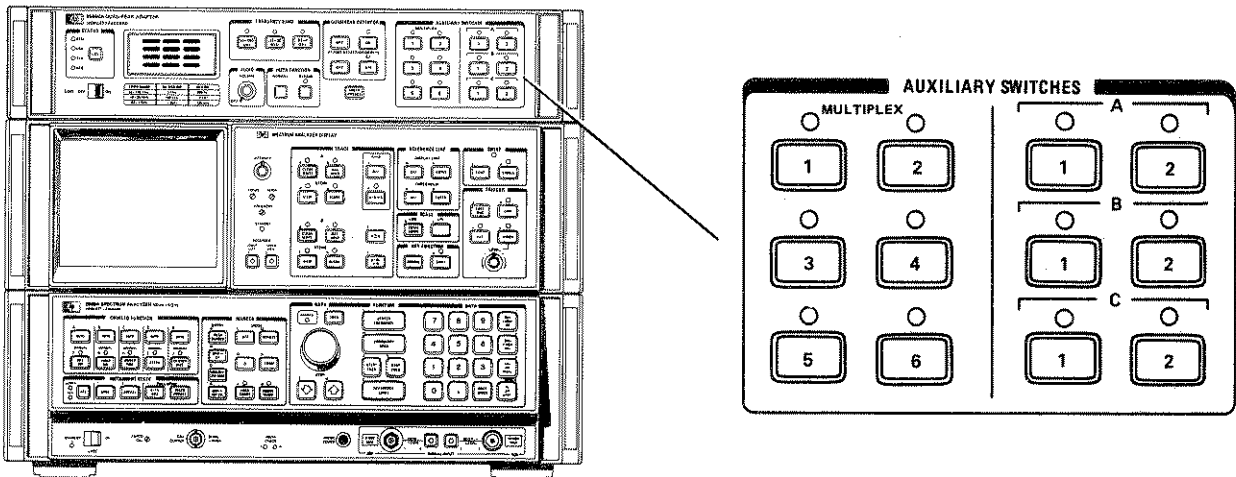

The quasi-peak adapter contains nine switchable relays connected to a rear panel connector. Each switch connects one of two paths and can be controlled from either the front panel or remotely via the HP-IB.

Six of the relays are configured in a MULTIPLEX fashion such that all but one is in a default position and the alternate path is selected by one and only one relay at a time.

The other three relays provide three dual-channel configurations. One of two paths for each of the three channels (A, B, or C) can be selected. Each channel can be selected independently of the others.

These relays can be used to switch system accessories such as attenuators, preamplifiers, and filters in and out of the measurement system using externally connected RF coaxial switches in conjunction with a DC power supply.

MULTIPLEX	Channel A	Channel B	Channel C
<input type="checkbox"/> 1 (MX1)	<input type="checkbox"/> 1 (SA1)	<input type="checkbox"/> 1 (SB1)	<input type="checkbox"/> 1 (SC1)
<input type="checkbox"/> 2 (MX2)	<input type="checkbox"/> 2 (SA2)	<input type="checkbox"/> 2 (SB2)	<input type="checkbox"/> 2 (SC2)
<input type="checkbox"/> 3 (MX3)			
<input type="checkbox"/> 4 (MX4)			
<input type="checkbox"/> 5 (MX5)			
<input type="checkbox"/> 6 (MX6)			

Status

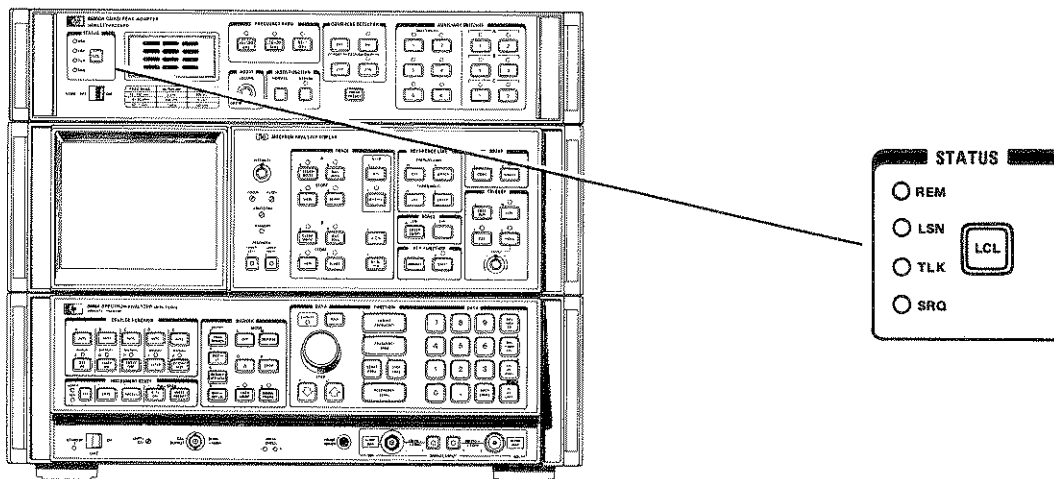

LCL Transfers control of the instrument from the HP-IB to the front panel. Front-panel controls are operative only in this mode.

Status indicators REM, LSN, TLK, and SRQ indicate the status of the HP 85650A as related to the HP-IB:

- REM Remote. Instrument is under control of the HP-IB.
- LSN Listen Mode. Instrument accepts commands from the HP-IB.
- TLK Talk Mode. Instrument transmits data to the HP-IB.
- SRQ Service Request. Instrument requests service.

Detailed information concerning use of the HP 85650A with the HP-IB is located in the HP-IB Remote Operation portion of this section.

- 1 **STATUS** indicators. Four LEDs indicate status of instrument operation. These indicators are:
 - REM — When lit, indicates remote operation.
 - LSN — When lit, indicates listen mode of operation.
 - TLK — When lit, indicates talk mode of operation.
 - SRQ — When lit, indicates a service request has been initiated by the instrument.

LCL key selects local operation (activates front-panel keyboard) when pressed. Refer to Appendix E for additional information.

- 2 Speaker. Produces audio output of video detected 21.4 MHz IF signal.

- 3 **FREQUENCY BAND** selection keys. Three keys provide frequency band selection of Quasi-Peak Adapter. Frequency band selected determines QPA (Quasi-Peak Adapter) bandwidth. Each key is provided with an LED indicator which is lit when key is pressed to indicate current frequency band selection.

- 4 **QUASI-PEAK DETECTOR** selection keys. These four keys are used to turn peak detector on or off and also to select signal gain at output of detector. ON and X10 keys are accompanied by LEDs to indicate active mode.

- 5 **AUXILIARY SWITCHES** control keys. These twelve keys are used to select relay contact closure for remote switches for each of the three frequency bands and to provide multiplex capability. LEDs are provided to indicate current selection.

- 6 **LINE** switch. Used to turn on and off the main ac line power to the instrument.

- 7 **FREQUENCY/BANDWIDTH** Table. Indicates SA (Spectrum Analyzer) and QPA (Quasi-Peak Adapter) bandwidths for each of the available frequency bands.

- 8 **AUDIO** control. Combination switch and potentiometer provides on/off and volume control for audio output.

- 9 **INSTR FUNCTION** selection keys. These keys are used to select quasi-peak capability or to bypass the Quasi-Peak Adapter. Bypass mode is indicated by lit LED accompanying key.

- 10 **INSTR PRESET** key. When pressed, this key sets each of the instrument functions to a predetermined state.

- 11 **FUSE F1**. Main ac line fuse. Fuse requirements for different line voltages are marked on panel.

- 12 **LINE V** connector. Main ac line input connector. Input voltage, frequency, and power consumption are labeled on panel. Use proper ac line cord as provided with instrument. When connected with the proper line cord, this connector provides necessary safety earth ground. Do not disable this grounding protection by use of adapters or extension cords not equipped with a grounding conductor.

- 13 **SELECTOR (Volts)** switches S1 and S2. Two switches provide adaptability of instrument to different ac line voltages. These line voltages, and switch settings for each, are labeled on panel.

- 14 **ADDRESS** switch. Five-segment switch used to select the HP-IB address to be used by the 85650A, when under remote control. Refer to Appendix A for additional information concerning HP-IB address selection.

- 15 **HP-IB** connector J1. HP-IB (Hewlett-Packard Interface Bus) connector. Provides remote programming capability via HP-IB. Connector and bus configuration conform to instrument interface

standard IEEE Std. 488-1978 'Digital interface for programmable instrumentation'. Refer to Appendix E for detailed information concerning use of the 85650A with the HP-IB.

- 16 **21.4 MHz IF INP** connector J3. BNC connector provides connection of 21.4 MHz IF output of spectrum analyzer to QPA.

- 17 **21.4 MHz IF OUT** connector J4. BNC connector provides connection of 21.4 MHz IF output of QPA to spectrum analyzer.

- 18 **QUASI-PEAK DETECTOR INP** connector J5. BNC connector provides connection of VIDEO output of spectrum analyzer to QPA.

- 19 **QUASI-PEAK DETECTOR OUT** connector J6. BNC connector provides connection of VIDEO output of QPA to spectrum analyzer.

- 20 **AUXILIARY SWITCHES** connector J2. Provides connection to internal relay circuits for selection of external switches from either front-panel keyboard or HP-IB.

- 21 **EXT AUDIO** connector J7. Phono jack provides output of audio signal for use by external speaker or headset. Internal speaker is disconnected when external audio connector is used.

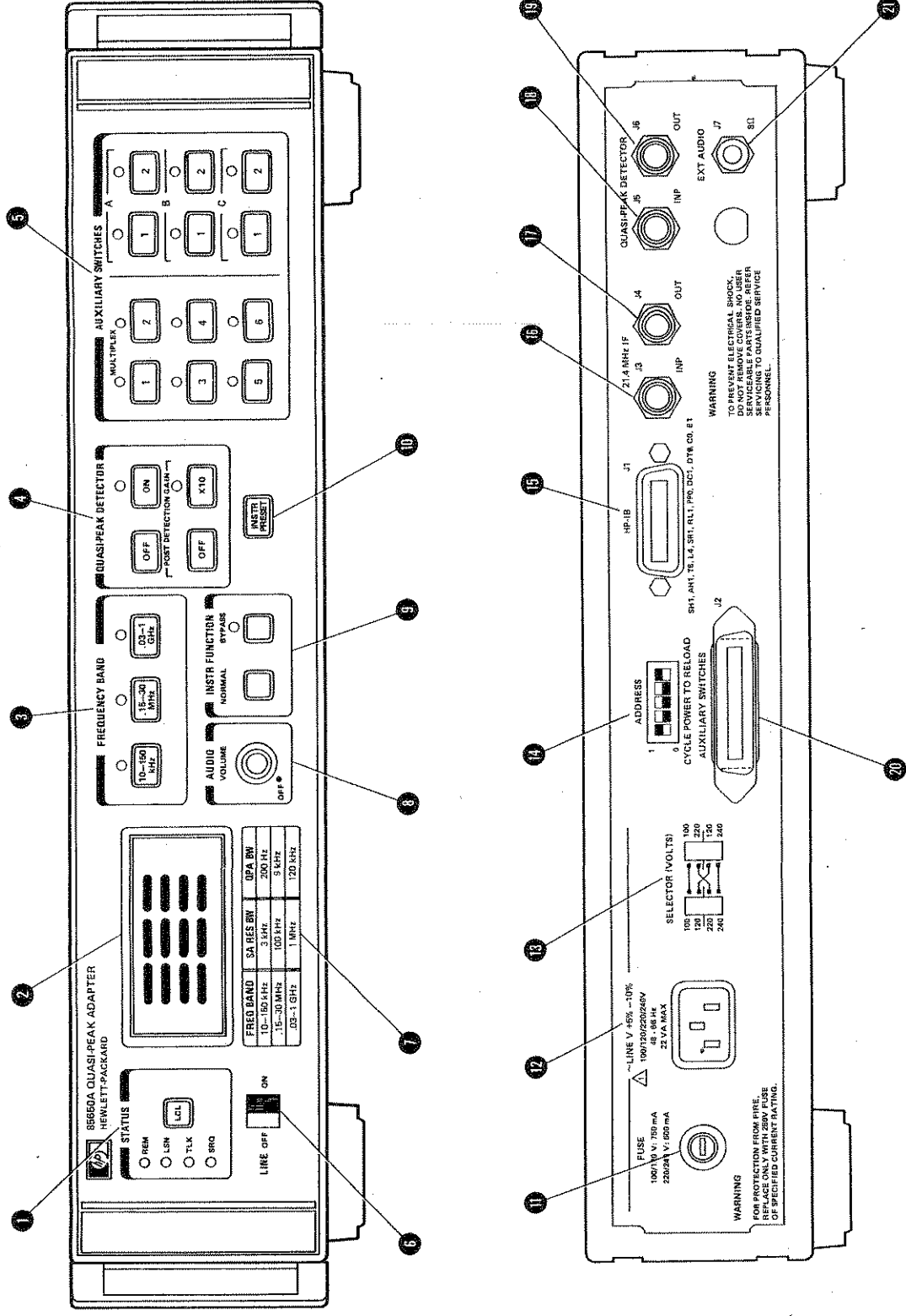

Figure 3-1. Explanation of Instrument Controls, Indicators, and Connectors

3-5. MEASUREMENT PROCEDURES

3-6. Fundamental Considerations in Operating the HP 85650A

There are three important points to keep in mind when operating the HP 85650A Quasi-Peak Adapter.

First, it should be remembered that proper resolution and video bandwidths must be selected on the spectrum analyzer for a given frequency band selected on the quasi-peak adapter. This is shown in the table below.

Quasi-Peak Adapter Frequency Band	Spectrum Analyzer Resolution Bandwidth	Spectrum Analyzer Video Bandwidth
10–150 kHz	3 kHz	3 kHz
.15–30 MHz	100 kHz	100 kHz
.03–1 GHz	1 MHz	1 MHz

The second important point is that the sweep time must be selected to be long enough to give accurate readings. The sweep time assigned automatically by the spectrum analyzer when it is in its coupled mode will not be long enough to give calibrated readings. For details regarding the allowable sweep times, see Measurement Considerations in this section.

The third important point is that, before the quasi-peak detector is turned on, the reference level should be adjusted so that the largest observed signal is near to, but not above, the top graticule of the CRT. Do not adjust the reference level with the quasi-peak detector on; it may cause the IF stage of the spectrum analyzer to overload.

3-7. Basic Procedures In Making Conducted and Radiated Emission Measurements

One of the big advantages of using a spectrum analyzer for making EMI measurements is its quick-look/full-span capability. This capability allows problem areas to be quickly spotted, then zoomed in on for further analysis.

CAUTION

It is possible to damage the attenuators of the HP 8566A or HP 8568A Spectrum Analyzer when switching between lines on a Line Impedance Stabilization Network (LISN) while making conducted emission measurements. To prevent this, a high pass filter and a limiter should be placed between the LISN and the spectrum analyzer. Details can be found in Product Note 85650A-1.

NOTE

To ensure measurement accuracy, be certain the spectrum analyzer is not overloaded. Details can be found in Product Note 85650A-1.

The first step in making a **conducted emission measurement** is to use peak detection¹ to locate problem areas. If the observed emissions exceed the regulatory limits at some frequencies, then these frequencies are zoomed in on for further analysis. After the reference level is adjusted and the span and sweep time set², the quasi-peak detector is turned on. If the measured amplitude is below the limit, then the EUT passes the test.

The procedure used to make **radiated emission measurements** depends upon the nature of the test site. If measurements are made in a semi-anechoic enclosure or at a remote open site where ambient signals are below the composite limits, then a quick-look/full-span procedure similar to the procedure used to make conducted measurements can be used. If, on the other hand, measurements are made at an open site where numerous ambient signals are above the composite limits, then one of two possible procedures is required.

One possible procedure is to make preliminary measurements in a shielded enclosure where ambient signals are not present. Frequencies at which emissions are noted are then rechecked at an open site. (For CISPR measurements, a shielded enclosure can be used to locate emissions, but not to measure emission amplitudes.)

The second possible measurement procedure is to select a relatively narrow measurement span (e.g., 1 MHz) then to tune the center frequency, keeping track of emissions as they are observed. The relatively narrow span is required in order to distinguish between ambient signals and signals from the EUT.

At open sites, ambient signals must be distinguished from signals emitted by the EUT. This can be done in four ways. First, a list of ambient signals that are always or almost always present in a given environment can be compiled. This allows some signals to be recognized as ambients based solely on the frequency of observation. Second, the sounds produced by emissions from a particular EUT may be unique and recognizable. Similarly, based on sound alone, ambient signals can often be identified. For this reason, a speaker has been provided in the HP 85650A Quasi-Peak Adapter. The appearance of signals provides a third clue as to their origin. Ambient signals often have characteristic appearances, as do emissions from many devices being tested. This is illustrated in Figure 3-2. The fourth and conclusive way to distinguish between ambient and emitted signals is to turn off the EUT. If the signal disappears, it is emitted by the EUT.

An additional complication in making radiated emission measurements is that some regulatory test procedures require that the EUT be rotated azimuthally or that the antenna be raised and lowered to find the positions which yield the maximum emission levels (as displayed on the spectrum analyzer). This can be time consuming if these rotations and elevations must be made for emissions at a large number of frequen-

¹ The suggested settings for the HP 85650A are:

INSTR FUNCTION	NORMAL
FREQUENCY BAND	15–30 MHz
QUASI-PEAK DETECTOR	OFF

Corresponding settings for the HP 8566A or 8568A are:

RES BW	100 kHz
VIDEO BW	100 kHz
START FREQ	0 Hz or lower frequency of regulatory limit (450 kHz for the FCC, 150 kHz for VDE)
STOP FREQ.	30 MHz
ATTEN.	10 dB
SWEEP TIME	$\geq .1$ sec/MHz x span (For example, 3 seconds for a 30 MHz span)

² For details regarding the selection of sweep time and span, refer to Measurement Considerations in this section.

cies. This is unavoidable at sites that have numerous ambients. At sites with a small number of ambients, however, the quick-look/full-span capability of the spectrum analyzer can greatly speed up measurements. The effect on emissions due to rotating the EUT or raising the antenna can be immediately observed. Only those emissions which exceed the composite limit line need to be investigated further.

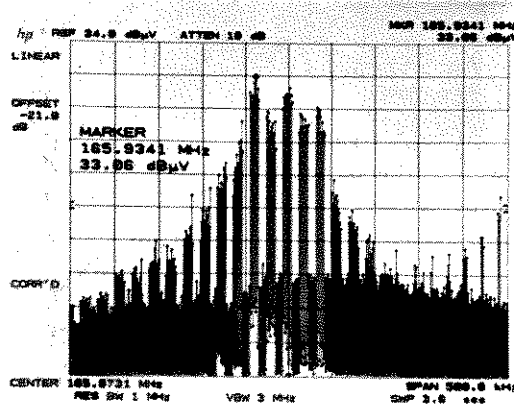

Figure 3-2. Radiated emissions from this EUT are clearly recognizable by their distinctive signatures.

As with conducted emission measurements, radiated emission measurements are first made using peak detection³. If the observed emissions exceed the composite limits at some frequencies, then those frequencies are zoomed in on for further analysis. After the reference level is adjusted and the span and sweep time set², the quasi-peak detector is turned on. If the measured amplitude is less than or equal to the composite limit, the EUT passes. Otherwise the EUT fails.

3-8. Measurement Examples

Examples of measurement procedures for making conducted and radiated measurements are shown in Figures 3-3 and 3-4, respectively.

³ Suggested settings for the HP 85650A are:

```

INSTR FUNCTION . . . . . NORMAL
FREQUENCY BAND . . . . . .03-1 GHz
QUASI-PEAK DETECTOR . . . . . OFF
    
```

Corresponding settings for the HP 8566A or HP 8568A are:

```

RES BW . . . . . 1 MHz
VIDEO BW . . . . . 1 MHz
Frequency Settings
Full-span method
START FREQ. . . . . Lower frequency limit of antenna
STOP FREQ. . . . . Upper frequency limit of antenna
Narrow-span method (for example, 1 MHz)
CENTER FREQUENCY . . . . . Tuned between 30 and 1000 MHz
ATTEN . . . . . 0 dB
SWEEP TIME . . . . . ≥ .2 sec/GHz x span
(For example, 40 milliseconds for a 200 MHz span)
    
```

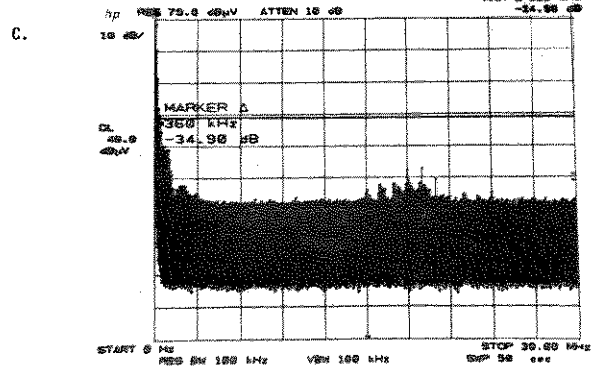
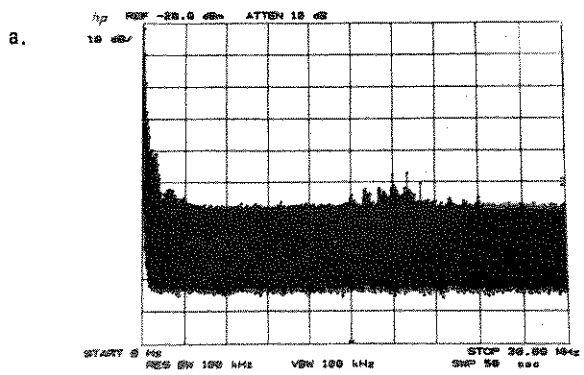

Conducted emissions observed using peak detection to test a computing device. The frequency band selected on the HP 85650A is .15–30 MHz and the instrument function is set to normal. The quasi-peak detector is turned off.

To conveniently display the frequency span containing those signals that are above the limit, the following procedure is used:

1. Press MARKER NORMAL (turns on the marker).
2. Place the marker at the left-most point on the trace.
3. Press MARKER Δ (turns delta marker on).
4. Place the second marker at a point on the trace that is just below the display line.

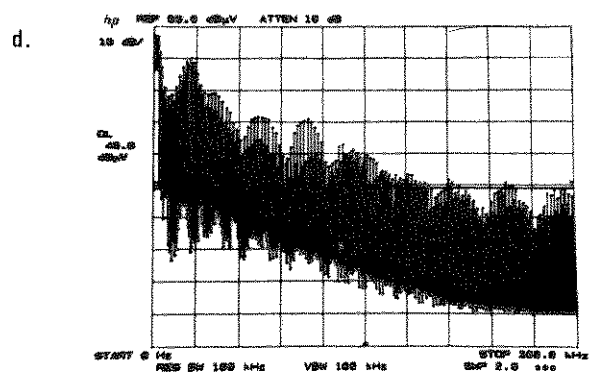
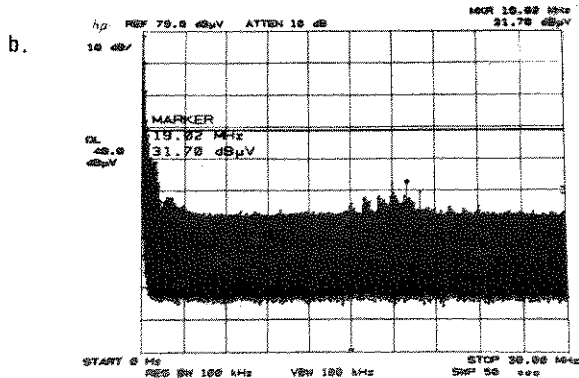

Display line represents 48 dB μ V limit for FCC Class B computing devices. Most signals are below the limit line. Since peak levels will always be at least as great as quasi-peak levels, these signals do not have to be investigated further.

With the locations of the two delta markers established in the previous step, the frequency range of interest is displayed by doing the following:

1. Press SHIFT.
2. Press MARKER Δ.

The impulsive nature of the interference is now evident from the spikes which are spaced at regular intervals. Increasing the sweep time causes these spikes to move closer together.

Figure 3-3. Procedure for Making Conducted Emission Measurements (1 of 2)

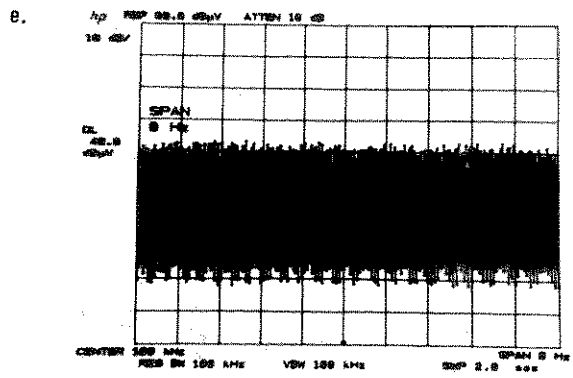

A large signal at 169 kHz is selected for further investigation. A span of 0 Hz is selected, (All emissions above 450 kHz are less than 48 dB μ V so the EUT passes the FCC conducted test for FCC Class B computing devices.)

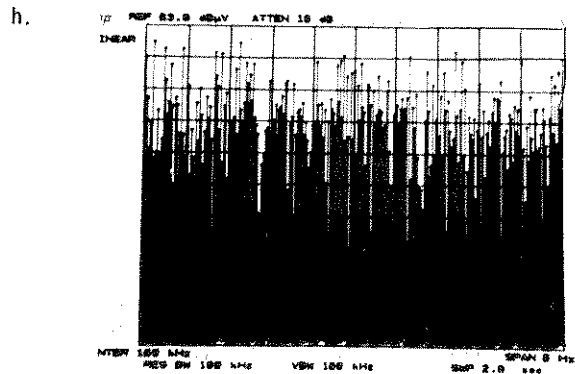

The reference level is adjusted so that the trace is near to, but not above the top graticule.

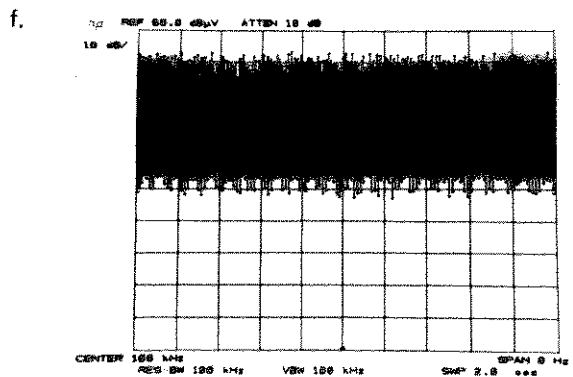

The reference level is decreased by 30 dB, raising the signal almost to the top graticule.

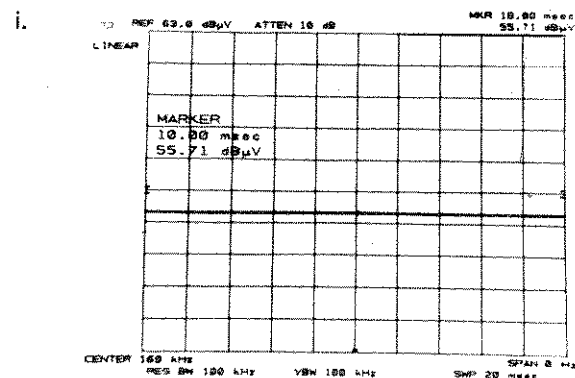

The quasi-peak detector is turned on. A marker indicates that the quasi-peak level is 55.71 dB μ V. Note that this is several dB below the level measured using peak detection (shown in the preceding photograph). (The noise floor of the spectrum analyzer is 22 dB μ V.)

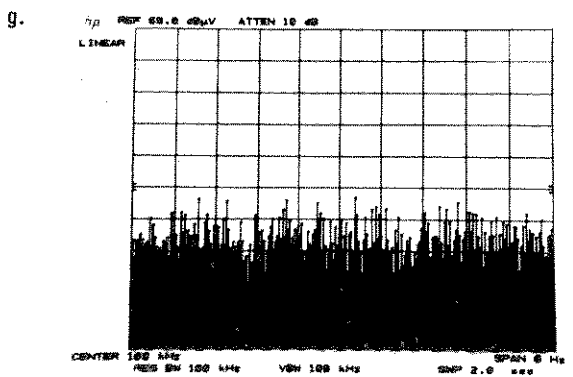

The spectrum analyzer is shifted from log mode to linear mode.

Figure 3-3. Procedure for Making Conducted Emission Measurements (2 of 2)

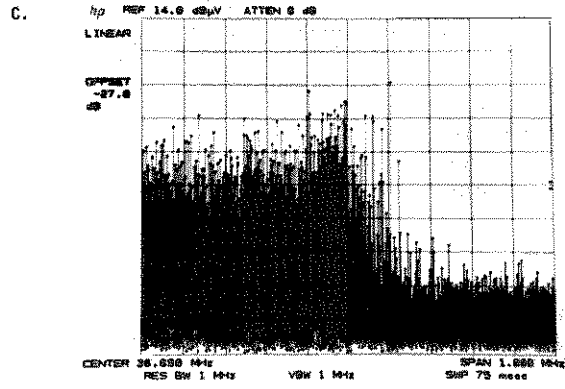
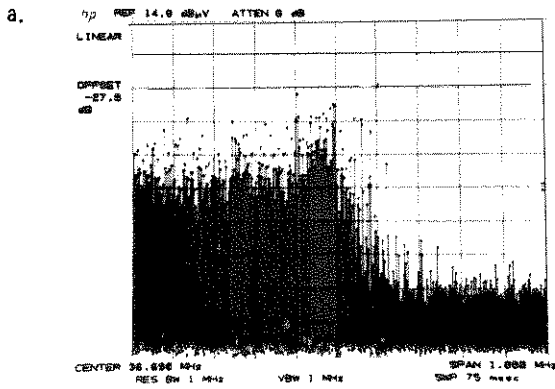

Shown above is a radiated emission from a computing device. Although the antenna used covers the 30-200 MHz frequency range, the span selected is only 1 MHz. The reason for this is that the measurement is made in a metropolitan area where ambient signals are numerous. If the full span were viewed at one time, it would be difficult to distinguish between the ambient signals and the signals emitted by the EUT.

The EUT is turned back on.

The frequency band selected on the HP 85650A is .03-1 GHz and the instrument function is set to normal. The quasi-peak detector is turned off.

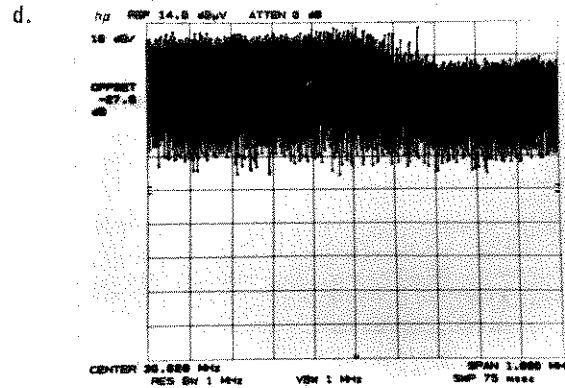

Since ambient signals as large as 73 dBμV are present at this site, the attenuation test is used to check for overload problems (gain compression or distortion). The spectrum analyzer is placed in log mode.

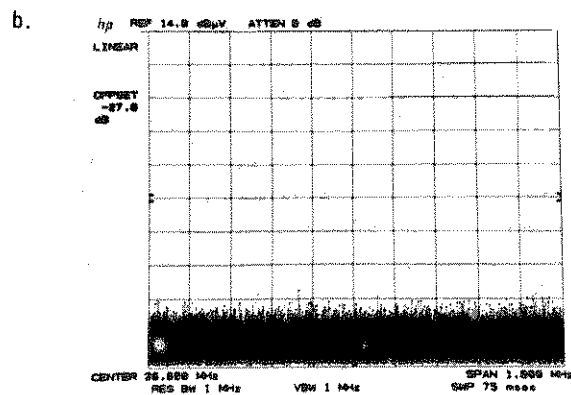

When the EUT is turned off, the signal disappears, indicating that it is not an ambient signal, but a signal emitted by the EUT.

Figure 3-4. Procedure for Making Radiated Emission Measurements (1 of 3)

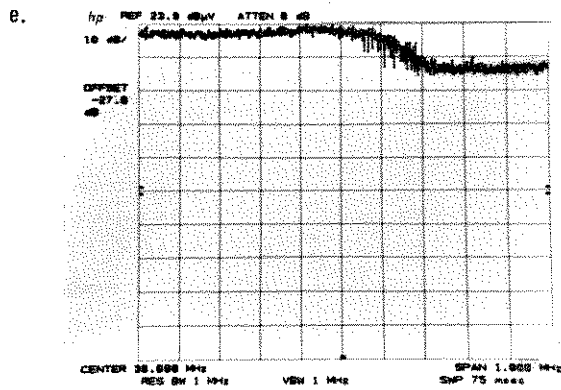

MAX HOLD is used to store the maximum values of the trace, obtained over several sweeps, into Trace Display A.

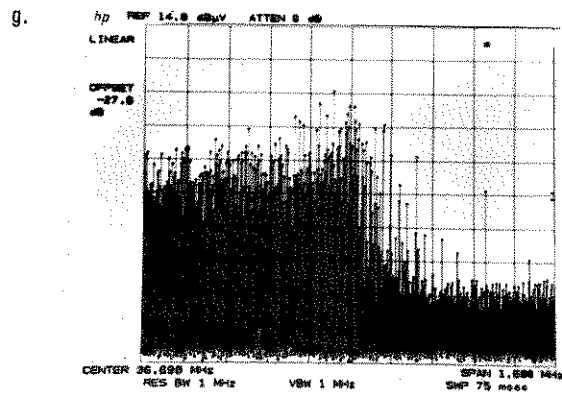

The spectrum analyzer is placed in linear mode to continue with the quasi-peak measurement.

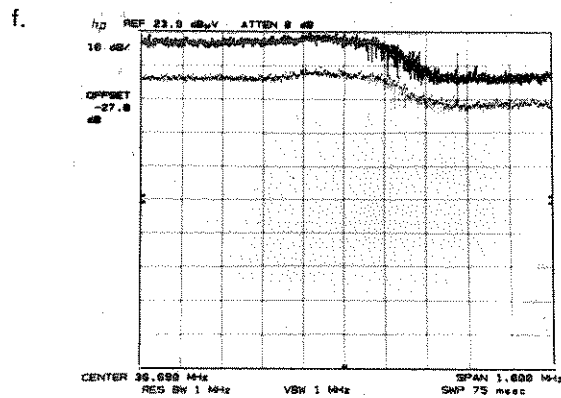

10 dB of external attenuation is placed in front of the pre-amplifier. The trace, obtained by taking several sweeps in MAX HOLD, is placed into Trace Display B.

Visual inspection reveals that the difference in dB between the two traces is about 10 dB for the left half of the display. This indicates that neither gain compression nor distortion is a problem. The difference in dB between the two traces on the right side of the display is slightly less than 10 dB. This does not indicate gain compression, however, but only that the signals measured are close to the noise.

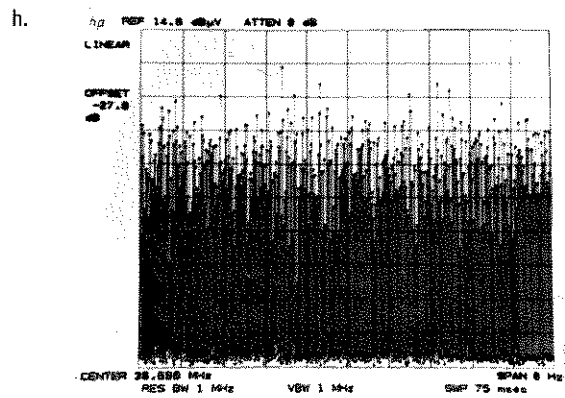

This display is centered about the largest part of the signal and zero span selected.

Figure 3-4. Procedure for Making Radiated Emission Measurements (2 of 3)

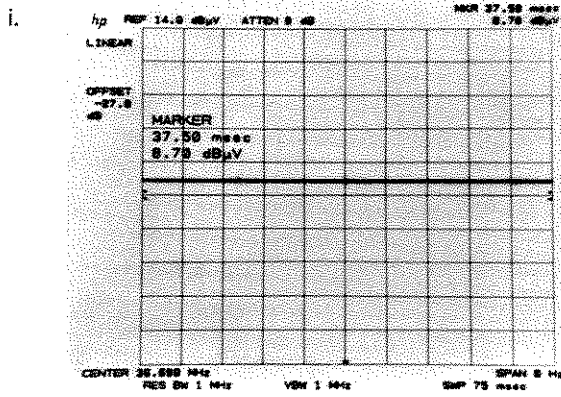

The quasi-peak detector is turned on. The antenna factor at this frequency for the antenna used is 12.4 dB/m. Thus the electric field strength of the radiated emission intercepted by the antenna is $8.7 \text{ dB}\mu\text{V} + 12.4 \text{ dB/m} = 21.1 \text{ dB}\mu\text{V/m}$. This is 8.4 dB below the FCC limit for Class A computing devices measured at 30 meters. (The effective noise floor with the preamplifier attached is $-1 \text{ dB}\mu\text{V}$.)

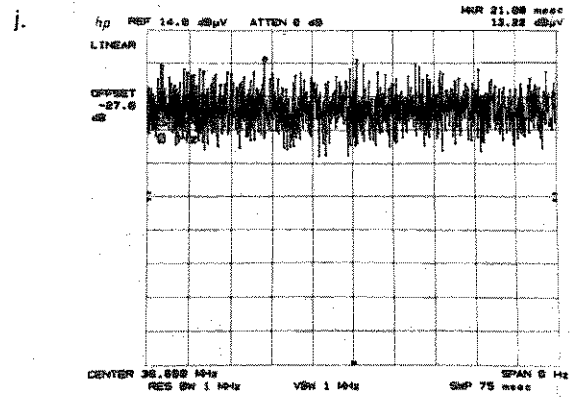

The quasi-peak detector is turned off and Trace A is placed in MAX HOLD. Note that the peak level is about 4 1/2 dB higher than the quasi-peak level.

Figure 3-4. Procedure for Making Radiated Emission Measurements (3 of 3)

3-9. MEASUREMENT CONSIDERATIONS AS RELATED TO SPECTRUM ANALYZER OPERATION

Adjustments of the HP 8566A and 8568A Spectrum Analyzers and characteristics of their particular design can affect the accuracy of the HP 85650A Quasi-Peak Adapter measurement. The purpose of this section is to inform the user of these potential sources of error, their estimated magnitude, and how to minimize their effect.

3-10. Digitizing and X10

When using the quasi-peak adapter, the spectrum analyzer is in linear display mode. In this mode, a signal at the top of the CRT has a digital value of 1000 display units. See Figure 3-5. A midscreen signal is 6 dB down and has a value of 500 display units. The smallest display unit is 1/1000 or 60 dB down. This is enough range to make quasi-peak measurements, but the resolution is unacceptable. A graph of digitizing resolution vs dB below top of CRT (Figure 3-5) shows that the step size becomes 1 dB or more 40 dB down on the linear display. To overcome this error, a fixed X10 (20 dB) gain can be switched into the quasi-peak detector signal path to raise the signal amplitude above this unacceptable digitizing range. Thus, the digitizing error of a signal quasi-peak detected to be 45 dB below the peak spectral intensity is less than .2 dB instead of 1.6 dB with X10 off.

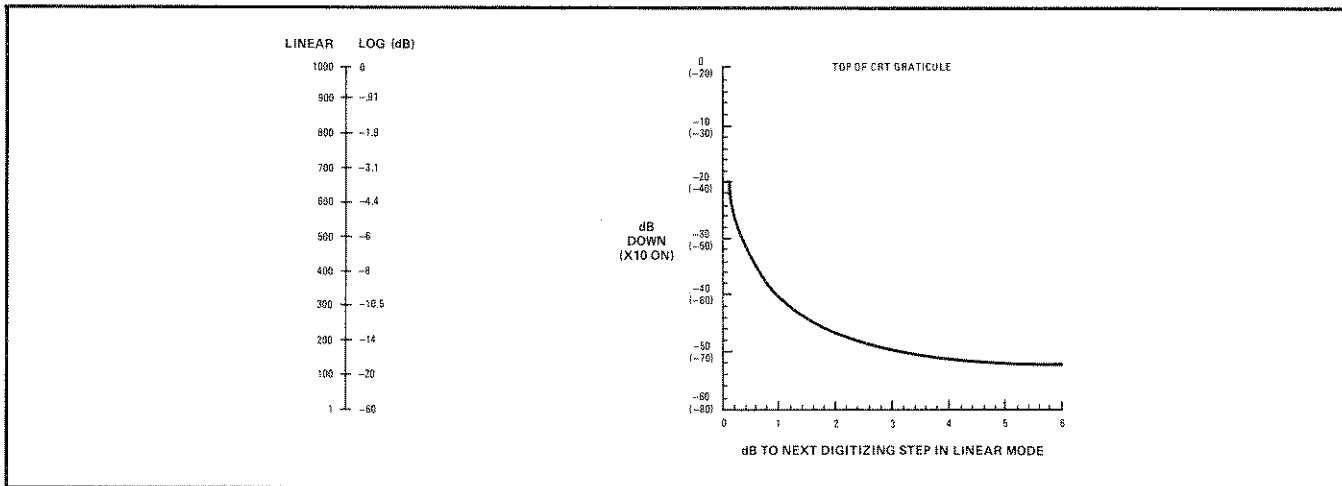

Figure 3-5. Digitizing Resolution vs dB Below Top of CRT

3-11. Offset Error

For measurements of low-repetition rate signal, the following should be considered. The video output of the spectrum analyzer normally goes directly to the display D/A Converter. See Figure 3-6. When connected to the HP 85650A, this path contains the quasi-peak detector.

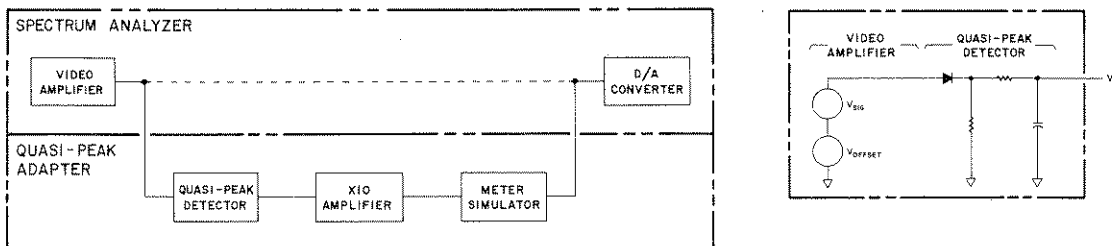

Figure 3-6. Simplified Diagram of Video Signal Path

For log-display signal analysis, the absolute value of zero is not meaningful, but for linear quasi-peak measurements, the zero of the display can be significant. Specifically, if some non-zero offset voltage is introduced into low-repetition pulse measurements, the effect is to raise or lower their absolute value. The magnitude of this error, for each of the three quasi-peak adapter bandwidths, for various offset voltage amplitudes is shown in Figure 3-7. For high-repetition rate signals, this is insignificant. It should be noted, however, that the X10 gain worsens the situation since the offset occurs before the X10 amplifier. To remove this offset, refer to HP 8566A or 8568A Operation and Service Manual Section V, Adjustments, and perform Video Processor and Track and Hold adjustments.

3-12. HP 8566A and 8568A Correction Routines (KSW)

With the HP 85650A in BYPASS mode, the spectrum analyzer correction routine (KSW) operates properly, but in NORMAL mode, some peculiarities may be observed with respect to center frequency. Because the spectrum analyzer bandwidth must be set wider than the quasi-peak adapter bandwidth, frequency corrections made on the spectrum analyzer filters may be on the order of the bandwidth of the quasi-peak adapter bandwidth. This will cause a shift, in the amount of the correction, to the center frequency readout on the spectrum analyzer. This shift can be compensated for by determining deviation of the calibrator from 20 MHz (or 100 MHz) and entering the deviation value as KSV (FREQ OFFSET). This enables direct entry of center frequency and also permits use of all correction routine features.

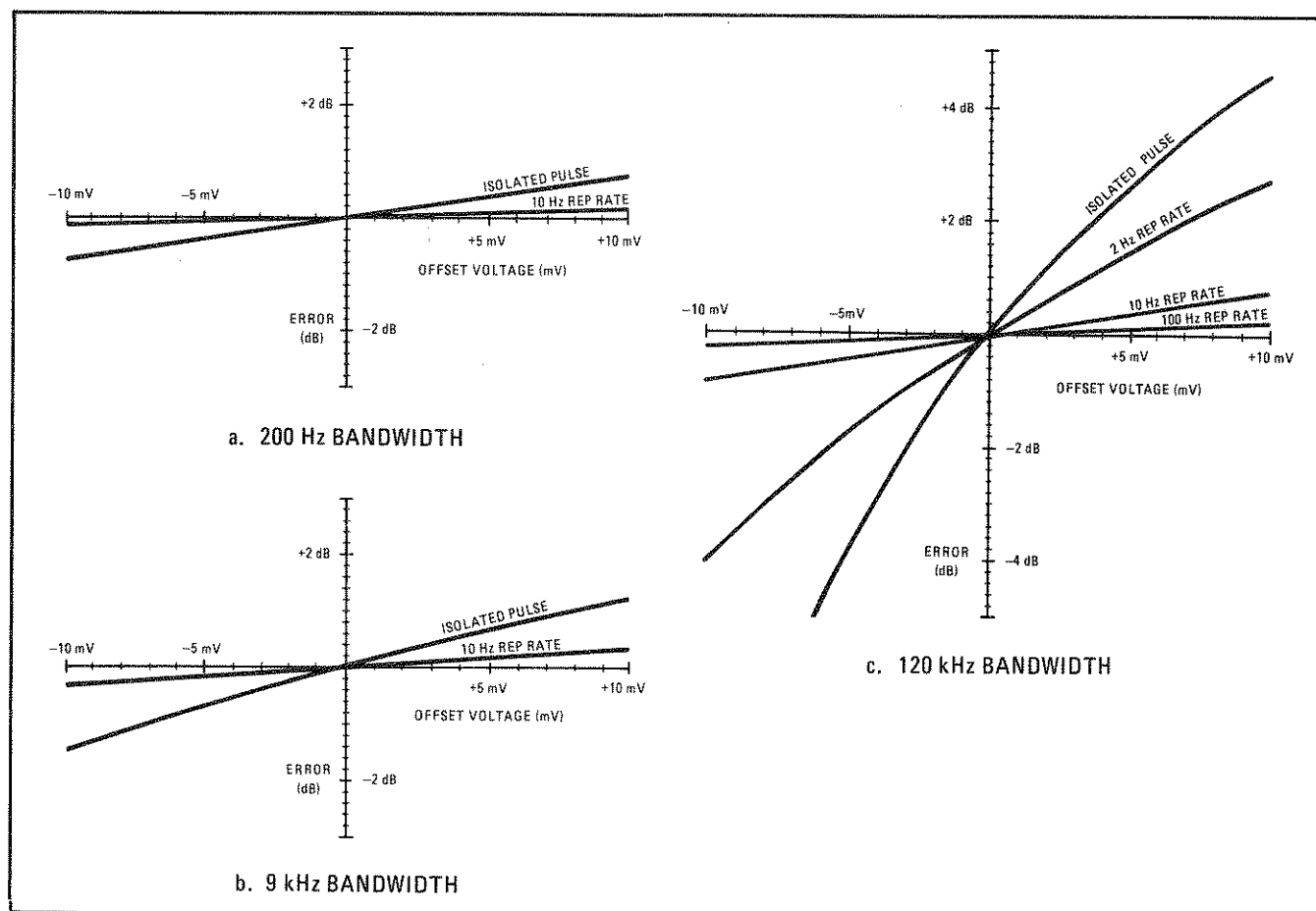

Figure 3-7. Measurement Error Due to Non-Zero Offset Voltage

3-13. Zero Span – 200 Hz BW

The spectrum analyzer corrects its center frequency to compensate for local oscillator (LO) drift as necessary. The algorithm for this takes into account the frequency span and the resolution bandwidth. In zero span, the resolution bandwidth determines LO retuning resolution. Because the 200 Hz quasi-peak adapter bandwidth is effectively more than 15 times narrower than the 3 kHz bandwidth of the spectrum analyzer, the retuning of the LO can cause several dB signal amplitude shift due to frequency shift on retuning. Typically, this occurs when viewing a very stable CW signal before the analyzer has temperature stabilized. A verification of signal amplitude can be performed by widening the span to a few hundred hertz, causing a much finer retuning of LO frequency.

3-14. Live IF, Retrace Ringing

Because the bandwidths of the quasi-peak adapter are external to and narrower than those of the spectrum analyzer, swept measurements pose a number of problems. In normal spectrum analyzer operation, the analyzer retunes center frequency during retrace, then waits at the low side of the sweep for any signal energy in the filters to stabilize before beginning another sweep. If a signal is in-band or at retuning frequency, energy will be stored in the quasi-peak adapter filters that cannot be dissipated during the start-of-sweep dead time. This will be seen as a transient response at the beginning of the sweep. Refer to Figure 3-8. The problem does not occur in zero span and may be eliminated in other spans by using slow sweep times.

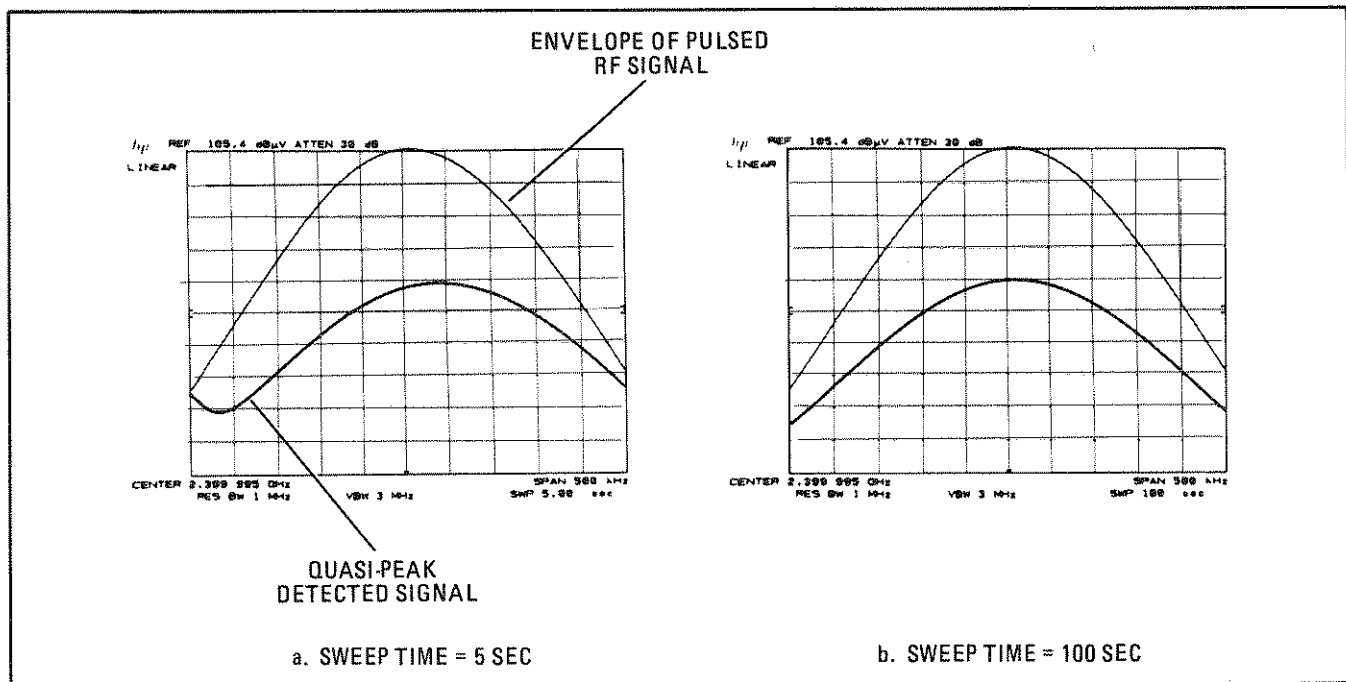

Figure 3-8. Examples of Retrace Ringing

Although slow sweep times eliminate this problem, techniques allowing the quasi-peak detector to partially discharge after retuning permit faster sweep times to be used.

With the HP 8566A Spectrum Analyzer, the technique is to:

- Retune center frequency
- Wait for quasi-peak detector to sufficiently discharge. (What constitutes sufficient discharge may require some user judgement.)
- Take sweep. (Single sweep rather than continuous sweep should be used.)

With the HP 8568A Spectrum Analyzer, the technique is to:

- Place marker at left edge of CRT display
- Retune center frequency
- Sweep-to-marker by pressing (KSu)
- Wait for quasi-peak detector to sufficiently discharge. (What constitutes sufficient discharge may require some user judgement.)
- Continue sweep-from-marker by pressing (KSt)

3-15. Sweep Time Considerations

When making quasi-peak measurements with the spectrum analyzer in zero span, it is most convenient to use as fast a sweep time as possible. But when making swept measurements over a non-zero frequency span with the quasi-peak adapter in NORMAL mode, it will be necessary to choose a slower sweep than would otherwise be selected by the coupled sweep time function of the spectrum analyzer. Because the filters used in the quasi-peak adapter are a different shape and bandwidth than the ones used in the spectrum analyzer, and because of the quasi-peak detector circuitry rise and decay time characteristics, amplitude errors of several dB could result from the selection of too fast a sweep.

CASE I: CW SIGNALS

For the case of CW signals, amplitude response is a function of the sweep rate, which is simply the ratio of frequency span to sweep time, and has units of kHz/sec. Two things can happen when too high a sweep rate is used which will cause amplitude errors. First, the quasi-peak adapter filters may overshoot or ring, as shown in Figure 3-9a. Secondly, the rise, decay, and display time constants in the quasi-peak adapter may be longer than the chosen sweep time, which means that the quasi-peak circuitry will never have time to fully respond and reach the true value. This is illustrated in Figure 3-9b.

Figures 3-10a, b, and c show empirical results of sweep rate vs amplitude error for each of the 3 bands. They can be used to help an operator choose an appropriate sweep time and span.

When using these curves, however, it is necessary to make sure that the values chosen are reasonable. In the 0.03 – 1 GHz band for example, a 2 kHz span and a 20 msec sweep time yield the same sweep rate (100 kHz/sec) as a 2 MHz span and a 20 second sweep time. This sweep rate value appears satisfactory from the graph, but the 20 msec sweep time is less than the decay and display time constants, so measurements made with a 20 msec sweep time would not yield valid results.

Figures 3-10d, e, and f are derived from the experimental data. They show lines of constant amplitude error for various sweep times and spans. The lines were obtained by noting the sweep rates on the graphs for the three frequency bands at which 1, 3, 5, and 10 dB amplitude error occurred. Knowing these sweep rates, the loci of points can then be drawn in. Note that there is a minimum sweep time limit which is governed by the time constants.

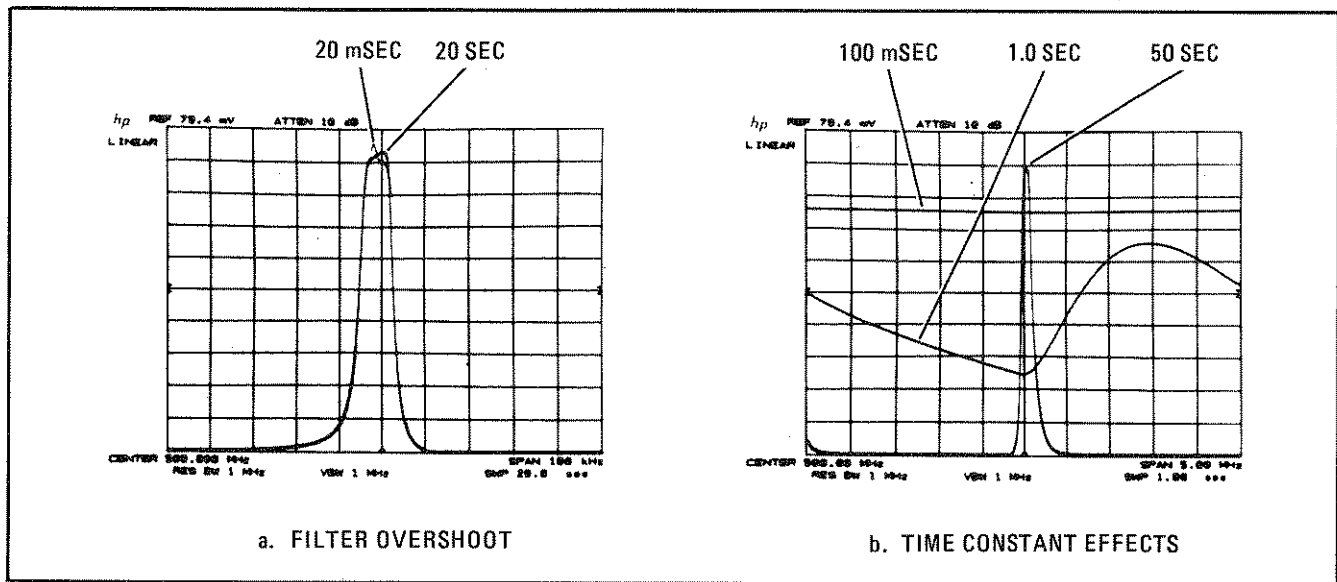

Figure 3-9. The Effects of Sweeping Too Fast

If the HP 85650A is left in the NORMAL mode, but the quasi-peak detector is turned off, it is possible to sweep at a faster rate than would otherwise be possible with the detector on. Figures 3-11a, b, and c show the empirical results of amplitude error vs sweep rate for the quasi-peak adapter with these settings. Comparing them to the curves of Figure 3-10, where the detector was turned on, we see that when the detector is not included in the circuit, a significantly faster sweep rate can be used. This is because the rise and decay and meter movement time constants no longer play a role as limiting factors of the sweep rate. Operating in this mode can be very useful for taking a quick look at a portion of the spectrum to see if any problem areas exist which need to be investigated more closely.

CASE 2: PULSE SIGNALS

For the case of pulse type signals, the choice of a proper sweep time is more difficult, since amplitude response will depend on several parameters. Pulse width, pulse repetition frequency (PRF), sweep time, frequency span and the particular quasi-peak adapter filter being used, can all affect the measured amplitude.

Figure 3-12a and 3-12b show the quasi-peak circuit responses of the 0.15–30 MHz and 0.03–1 GHz bands for signals with a 100 Hz PRF and varying pulse widths. These pulse widths were chosen such that their main lobes correspond to .1, 1, and 10 times the 6 dB bandwidth of the IF filter in the quasi-peak adapter⁴. In both bands, the pulse whose main lobe width is equal to the filter bandwidth produces the worst response. This would be expected, since the output of the IF filter for such a signal never remains constant for a long enough time, but rather varies continuously as the sweep passes across the main lobe. When this happens at a rate comparable to the time constants governing that particular frequency band, the inability of the circuitry to respond fast enough to changing inputs causes an error in the reading.

⁴ Recall that for pulsed RF signals, a pulse of width τ second will have a $\sin x/x$ spectral envelope with a main lobe width of $2/\tau$ Hz.

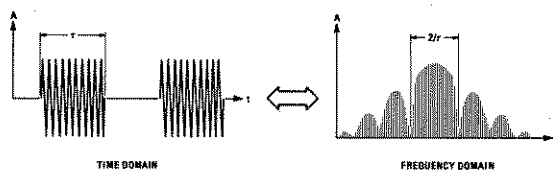

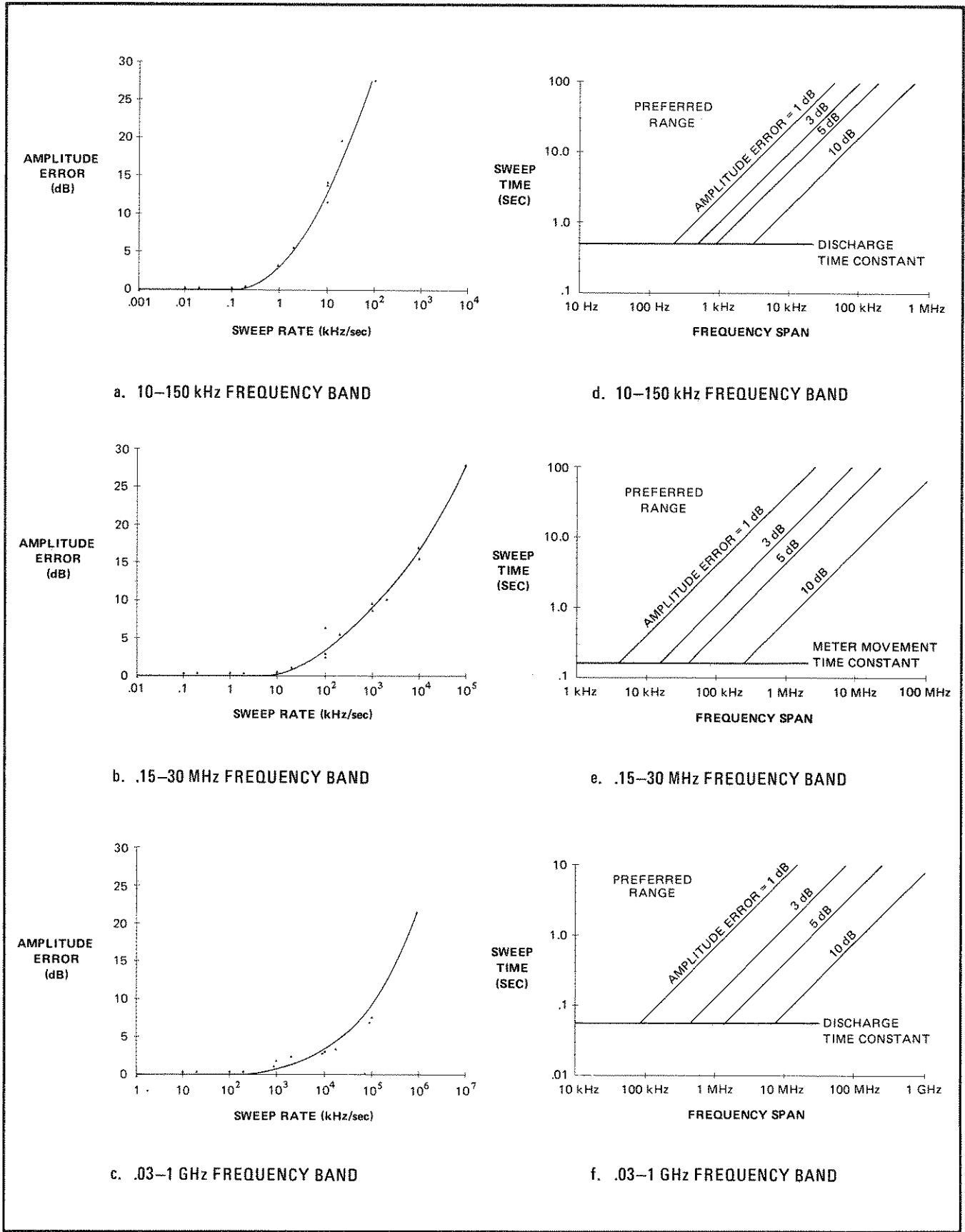
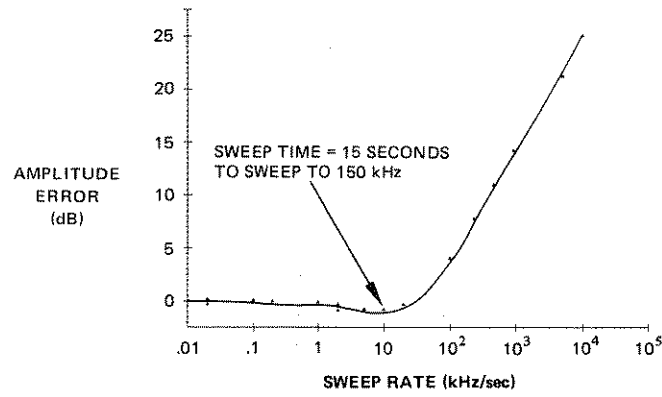
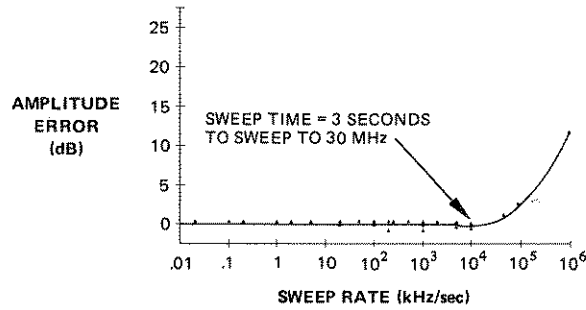

Figure 3-10. Empirical Results of Amplitude Error vs Sweep Rate for CW Signals with the Quasi-Peak Detector On



a. 10-150 kHz FREQUENCY BAND



b. .15-30 MHz FREQUENCY BAND

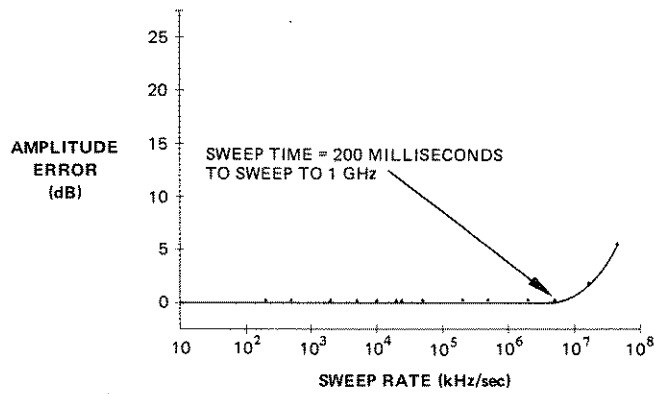

c. .03-1 GHz FREQUENCY BAND

Figure 3-11. Empirical Results of Amplitude Error vs Sweep Rate for CW Signals with the Quasi-Peak Detector Off

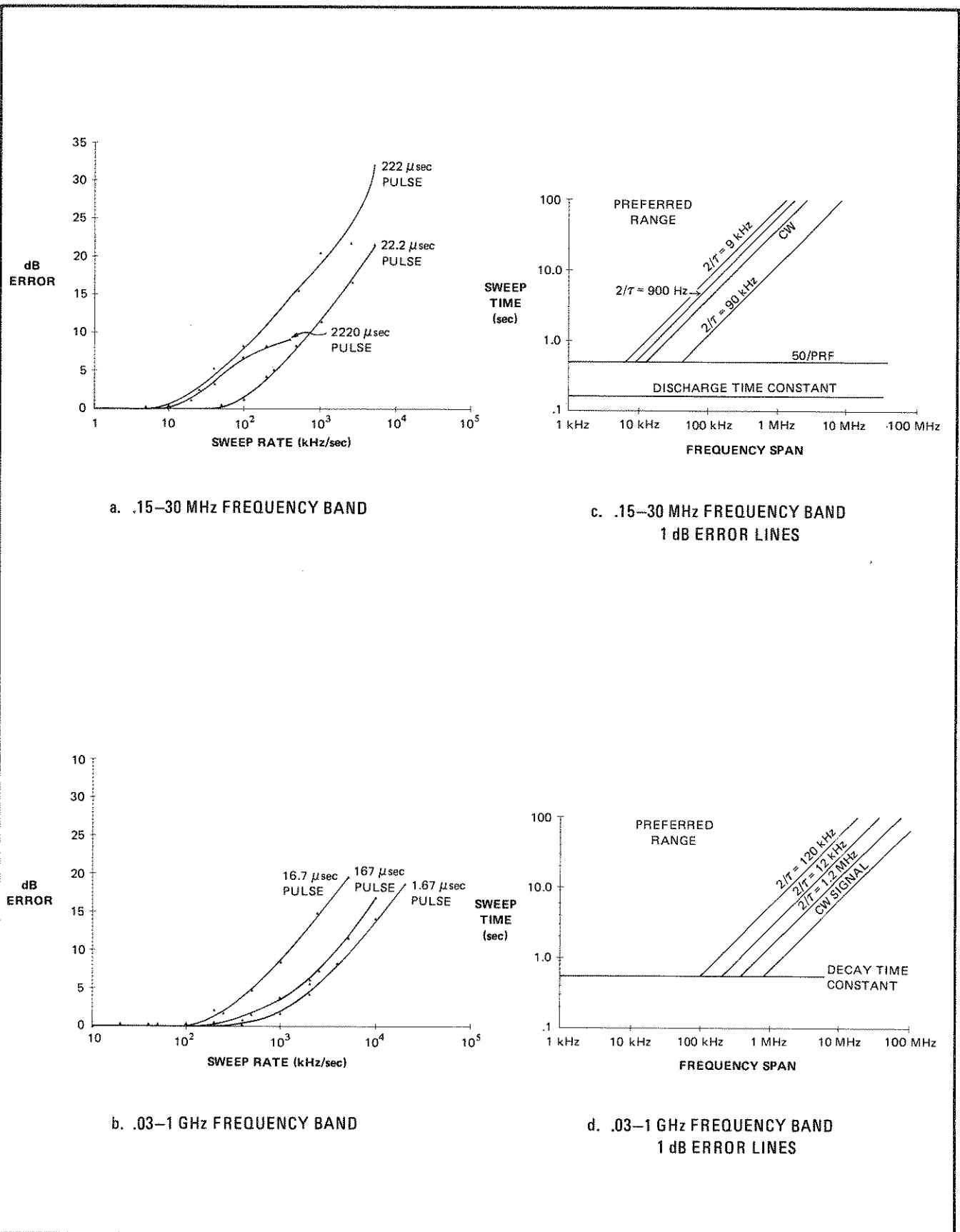

Figure 3-12. The Effect of Pulse Width on Quasi-Peak Filter Response for an Input Signal with a 100 Hz PRF

From the experimental data shown in Figures 3-12a and 3-12b, we can construct graphs of the 1 dB error lines, as in Figures 3-12c and 3-12d. Lines are plotted for the three types of pulses (with narrow, medium, and wide main lobes relative to the IF bandwidth) and for CW signals. The region to the left of the lines is the preferred measuring range, since operating in this area will give results that are within 1 dB of the amplitude measured in zero-span. In addition to these limits, there is always an ultimate sweep time limitation. This can be a time constant limitation of the filter or meter movement, or a requirement to capture a certain number of pulses during a sweep. For example, suppose that in the .15 – 30 MHz band, we want to intercept at least 50 pulses during one sweep. If the signal of interest has a 100 Hz PRF, then the minimum sweep time is 50/PRF, or 0.5 seconds, regardless of the frequency span chosen.

Signals with low PRF's such as 1 or 2 Hz pose an additional problem not generally encountered with high repetition rate signals, such as those in Figure 3-12 which had a 100 Hz PRF. When measuring a signal with a low PRF, the probability of intercepting and capturing a pulse becomes an important factor. Suppose for example that we wish to measure the quasi-peak level of a pulsed signal which has a 1 Hz PRF. If we were to choose a sweep time of 100 milliseconds, the probability of intercepting a pulse at some point during the sweep is only 1/10. Moreover, in order to capture the peak of the main lobe, the analyzer should sweep slow enough for the analyzer to receive several pulses while the filter sweeps past the main lobe.

Figures 3-13a and 3-13b show quasi-peak readings of a signal with a 1 Hz PRF. Notice how the 50 second sweep intercepts many pulses and the peak of the main lobe is easily found. But the 10 second sweep failed to capture the maximum response because a pulse did not occur at the moment that the sweep was at the peak of the main lobe.

There is no set formula for determining the proper sweep time for signals with low repetition rates because of all the variables involved. It may be necessary for the operator to try different sweep times and use good judgment to determine how fast a sweep is possible without sacrificing amplitude accuracy.

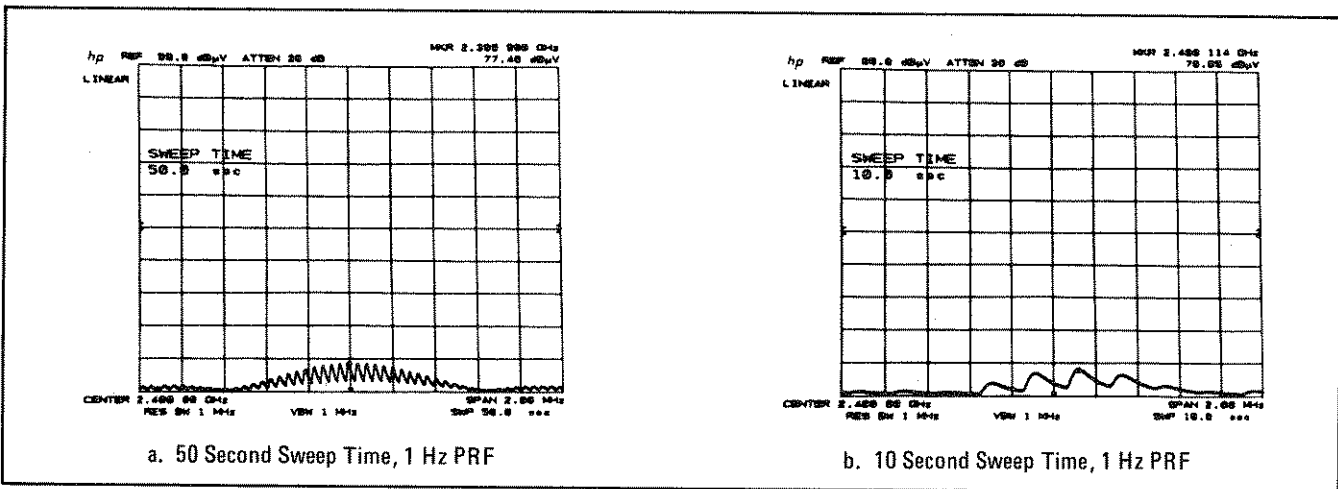

Figure 3-13. The Effect of Sweep Time on Measurement of Low-Repetition Rate Signals

3-16. HP-IB REMOTE OPERATION

This material covers operation of the HP 85650A Quasi-Peak Adapter using a remote controller and the Hewlett-Packard Interface Bus (HP-IB)⁵.

⁵ HP-IB (Hewlett-Packard Interface Bus) is the Hewlett-Packard implementation of IEEE STD 488-1978 and ANSI STD MC1.1, 'Digital interface for programmable instrumentation'.

3-17. HP-IB Capability

The interface functions supported by the HP 85650A Quasi-Peak Adapter are summarized by the following codes: SH1, AH1, T6, L4, SR1, RL1, PP0, DC1, DT0, C0, E1. This capability information conforms to definitions as outlined in IEEE STD 488-1978 (and identical ANSI STD MC1.1). A more detailed bus capability of the HP 85650A is outlined in Table 3-1.

Table 3-1. HP-IB Interface Capability of the HP 85650A

HP-IB Message	Related Mnemonics	Instrument Response
Data		Full capability.
Trigger	GET	No capability.
Clear	DCL, SDC	Clear status byte. Reset syntax processor (any partial commands are lost).
Remote	REN	Instrument under control of remote (HP-IB) device; front panel controls are inoperative (except LCL).
Local	$\overline{\text{REN}}$, GTL	Front panel controls are operative.
Local Lockout	LLO	Front panel LCL key disabled.
Clear Lockout, Local	$\overline{\text{REN}}$	Front panel LCL key enabled; front panel controls are operative.
Require Service	RQS	Instrument may request service.
Status Byte	SPE, SPD	Clear bit 6 of status byte.
Status Bit		No capability.
Pass Control	TCT	No capability.
Abort	IFC	Unaddresses instrument. Clear bit 6 of status byte.

3-18. Addressing the HP 85650A

Communication between instruments on the HP-IB requires that a unique address be assigned to each instrument. The HP-IB address switch for the HP 85650A is shown in Section II, Installation, in its factory preset position, decimal 17 (ASCII Q1). Refer to Section II for additional information concerning HP-IB address selection.

3-19. Programming Codes

All front-panel functions except LINE and AUDIO VOLUME can be accessed remotely via the HP-IB. The programming codes for control of front-panel functions are indicated with the corresponding manual operation information in the portion of this section entitled Operating the HP 85650A. In addition to those commands directly related to front-panel functions, several HP-IB only commands are available for use with a remote controller. These commands are discussed in detail in the following paragraphs. A complete listing of all programming codes is contained in Figure 3-14 at the end of this section.

Output Commands

The following output commands are available for use with a remote controller. These commands allow the computer to determine what the operator would see when viewing the front panel.

ID Identification. This command is used to identify the instrument. When this command is sent by the controller, the HP 85650A returns '85650A QUASI-PEAK ADAPTER'. This 'tells' the controller that the HP 85650A is connected to the HP-IB and powered up.

OA Output Active Function. This command is used to determine the current status of **any** of the HP 85650A programmable front-panel functions.

The information returned by the HP 85650A, after receiving the OA command, provides the controller the same information that the front-panel LEDs provide the operator for any front-panel function. Refer to OA command under Syntax Reference for additional information.

OL Output Learn String. This command is used to determine the current status of **all** of the HP 85650A programmable front-panel functions.

The information returned by the HP 85650A, after receiving the OL command, provides the controller the same information that the front-panel LEDs provide the operator for all front-panel functions. Refer to OL command under Syntax Reference for additional information.

OM Output Memory. This command is used to provide information for a service routine. Refer to A2 Motherboard Troubleshooting in Section VIII, Service, for details.

Service Request Command

RS Require Service. Use of this command allows the HP 85650A to request service when certain specifically defined conditions exist. Refer to RS command under Syntax Reference for additional information.

3-20. Syntax Reference

When addressing the HP 85650A from a remote controller via the HP-IB, a specific format of instructions or commands must be used. This material describes the proper sequence of commands over the bus to achieve a desired result in the HP 85650A, and the resulting output from the HP 85650A.

The information here is presented such that it is controller independent; that is, there is no reference to any specific controller or programming language. The controller used, however, must be HP-IB compatible.

A pictorial representation is used here to indicate the format or sequence of commands passed over the bus. These diagrams represent only the information actually passed over the bus and not the information flow within either the controller or the HP 85650A. To relate this information to a specific controller, refer to the controller programming manual and any HP-IB Programming Notes relating to the HP 85650A and HP 8568A or HP 8566A.

In these pictorial diagrams, literal ASCII characters are shown in bold typeface within rounded envelopes. These characters are transmitted (in binary form) exactly as shown. Items within rectangular boxes require additional explanation. Such items may relate to a command which will be different for different controllers or to a function which has additional data associated with it.

Items which are unique to a particular command are discussed with the explanation of that command. The following items are used repeatedly in the diagrams so are described only once here.

Item	Definition	Explanation*	ASCII Code**
Output	UNL TA21 LA17	UNListen Talk Address 21 Listen Address 17	? U 1
Enter	UNL LA21 TA17	UNListen Listen Address 21 Talk Address 17	? 5 Q
Additional Commands	Any 85650A front-panel programming code (two or three character mnemonic).		Refer to Figure 3-14 for front-panel programming codes.
*Factory preset addresses for both the HP 85650A and HP computing controllers are used here. **These are the actual ASCII characters transmitted on the HP-IB.			

Note that data on the bus originates from the controller (controller is talker) until an "Enter" block is transmitted. Data then originates from the HP 85650A (HP 85650A is talker).

Front-Panel Commands

A0, A1, BP, FR1, FR2, FR3, IP, MX1, MX2, MX3, MX4, MX5, MX6, NM, Q0, Q1, SA1, SA2, SB1, SB2, SC1, SC2.

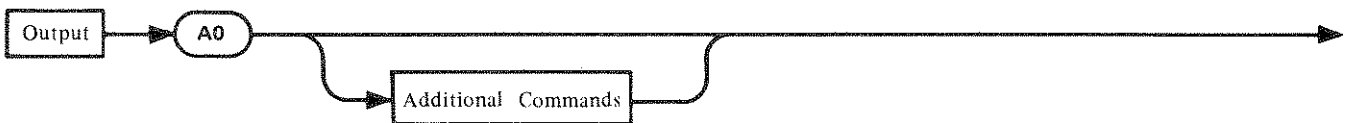

Mnemonic A0 may be replaced with any of the two or three character front-panel programming codes listed above and also in Figure 3-14; all front-panel commands follow the same format.

One or more commands may be sent in the same statement as indicated by the Additional Commands block with an alternate path around the block.

Output Commands

OA Output Active Function



Mnemonic QP in the first envelope may be replaced with any one of seven two-letter mnemonics representing an HP 85650A front-panel control group. These mnemonics are listed in Table 3-2.

Status Code refers to a three-digit (ddd) code which represents the status of the function being interrogated. Table 3-2 lists these codes and associated function group status.

(EOI) indicates the HP-IB EOI line is pulled low (true) when the LF command is transmitted.

OL Output Learn String

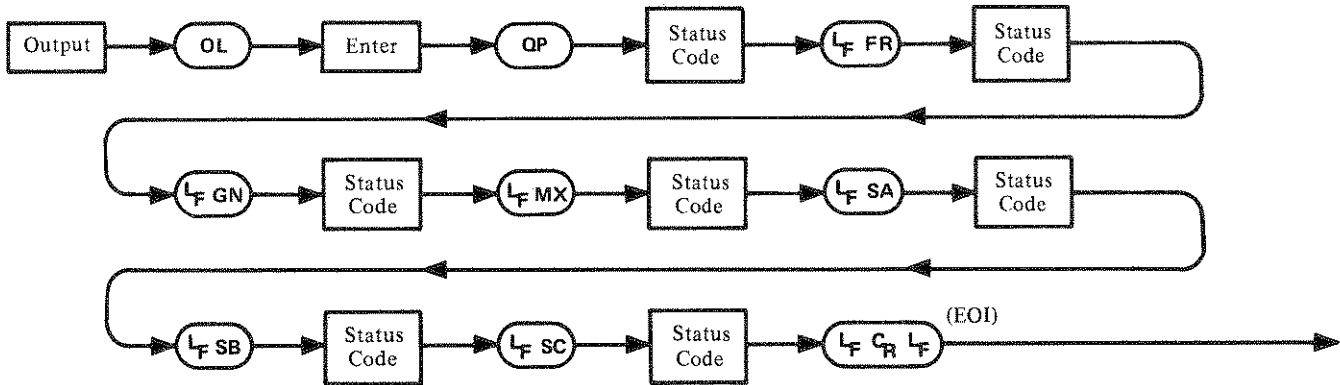

Mnemonics QP, FR, GN, MX, SA, SB, SC refer to seven front-panel control groups. These mnemonics are listed in Table 3-2.

Status Code refers to a three-digit (ddd) code which represents the status of the function group indicated by the preceding two-letter mnemonic. Table 3-2 lists the three-digit status codes and associated function group status. A LF is sent after each five-character (two-letter/three-digit) string before the next string is sent.

(EOI) indicates that the HP-IB EOI line is pulled low (true) when the LF command is transmitted after the last five-character string is sent.

OM Output Memory



Service Data is 2048 bytes of information pertinent to semi-automatically servicing the HP 85650A. The decimal sum of the low-order 8 bits of the 2048 bytes should equal 255. Use of this service data is explained in detail in Section VIII, Service, under A2 Motherboard Troubleshooting.

(EOI) indicates that the HP-IB EOI line is pulled low (true) when the LF command is transmitted.

ID Identification

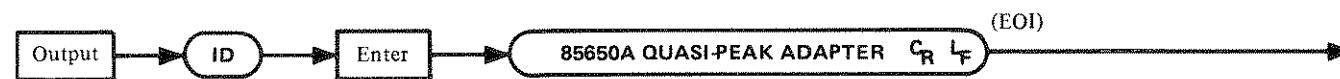

(EOI) indicates that the HP-IB EOI line is pulled low (true) when the LF command is transmitted.

Table 3-2. Function Group Mnemonics and Status Codes

Function Group Mnemonic	Status Code	Function Group Status
QP	160	BYPASS - Quasi-Peak Detector ON
	032	BYPASS - Quasi-Peak Detector OFF
	000	NORMAL - Quasi-Peak Detector OFF
	128	NORMAL - Quasi-Peak Detector ON
FR	001	10-150 kHz Frequency Band (200 Hz BW)
	002	15-30 MHz Frequency Band (9 kHz BW)
	003	.03-1 GHz Frequency Band (120 kHz BW)
GN	001	Post-Detection Gain OFF
	002	Post-Detection Gain ON
MX	001	Multiplex switch 1 selected
	002	Multiplex switch 2 selected
	003	Multiplex switch 3 selected
	004	Multiplex switch 4 selected
	005	Multiplex switch 5 selected
	006	Multiplex switch 6 selected
SA	001	Channel A switch path 1 selected
	002	Channel A switch path 2 selected
SB	001	Channel B switch path 1 selected
	002	Channel B switch path 2 selected
SC	001	Channel C switch path 1 selected
	002	Channel C switch path 2 selected

Service Request Command

RS Require Service



Mask refers to a decimal byte representing a service request mask as follows:

Bit	Description
0	Not used*
1	Not used*
2	Illegal analyzer command
3	Not used
4	HP-IB error (hardware broken)
5	Not used
6	Universal HP-IB RQS bit
7	Command (HP-IB or front-panel) complete (not busy)

*Bits 0 and 1 are implemented for service purposes and correspond to T0 and T1 test inputs to the 8748 microprocessor.

When one of the conditions described by bit 2, 4, or 7 exists, and that bit is enabled in the Mask, bit 6 is set by the Quasi-Peak Adapter to signal the controller that service is required. The Mask may be assigned to allow a request for service to be generated for any or none of these conditions. Table 3-3 lists all of the possible combinations and the corresponding Mask for each.

Table 3-3. Possible Service Request Masks

BITS ENABLED	MASK (DECIMAL)**
None	0
2	4
4	16
7	128
2, 4*	20*
2, 7	132
4, 7	144
2, 4, 7	148
<p>*Selected with IP (Instrument Preset) **Since bit 6 is necessarily enabled during a service request, the status byte transmitted on the HP-IB is equivalent to decimal 64 (or 2^6) plus the value of the bit representing the service request.</p>	



PROGRAMMING CODES

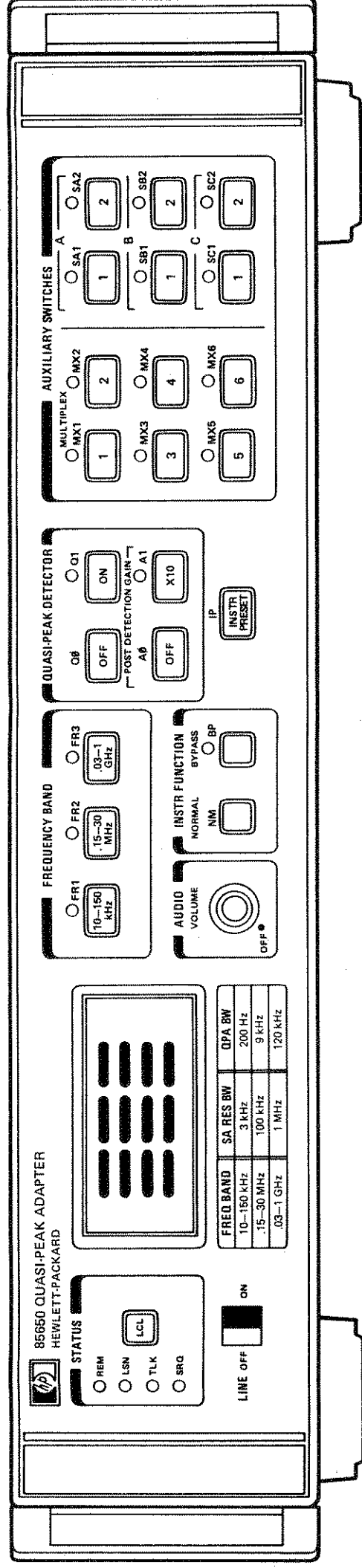

FRONT PANEL COMMANDS

Frequency Band

- FR1** Selects 200 Hz resolution bandwidth for 10 to 150 kHz frequency band (Band A) quasi-peak detector characteristics.
- FR2** Selects 9 kHz resolution bandwidth for .15 to 30 MHz frequency band (Band B) quasi-peak detector characteristics.
- *FR3** Selects 120 kHz resolution bandwidth for .03 to 1 GHz frequency band (Band C/D) quasi-peak detector characteristics.

Instr Function

- NM** Selects quasi-peak adapter function.
- *BP** Bypasses quasi-peak adapter.

Quasi-Peak Detector

- *Q0** Turns quasi-peak detector off.
- Q1** Turns quasi-peak detector on.

- *A0** Turns post detection amplifier off.
- A1** Turns post detection amplifier on.

Instr Preset

- IP** Selects instrument preset conditions as indicated by asterisk (*) in this list of codes.

Auxiliary Switches

- *MX1** Selects auxiliary switch 1.
- MX2** Selects auxiliary switch 2.
- MX3** Selects auxiliary switch 3.
- MX4** Selects auxiliary switch 4.
- MX5** Selects auxiliary switch 5.
- MX6** Selects auxiliary switch 6.

- *SA1** Selects Switch A, path 1.
- SA2** Selects Switch A, path 2.

- *SB1** Selects Switch B, path 1.
- SB2** Selects Switch B, path 2.

- *SC1** Selects Switch C, path 1.
- SC2** Selects Switch C, path 2.

OUTPUT COMMANDS

- ID** Identification command. Sends '85650A QUASI-PEAK ADAPTER'.
- OA** Outputs active function.
- OL** Outputs learn string.
- OM** Outputs Memory (Service Routine)

SERVICE REQUEST COMMAND

- *RS** Zeros quasi-peak detector.
- *** Enables service request.

*Selected with IP (Instrument Preset).

